

TRIDEN



SUPPLY CATALOGUE



TRIDEN

DISTRIBUTORS

Business Hours:

Monday to Friday - 8:00 a.m. to 5:00 p.m.

Order Pick Up - 8:00 a.m. to 4:00 p.m.

905-421-2955

Toronto Line: 416-291-2955

Fax: 905-421-9780

Phones answered automatically 24 hours a day.

Please feel free to leave a message.

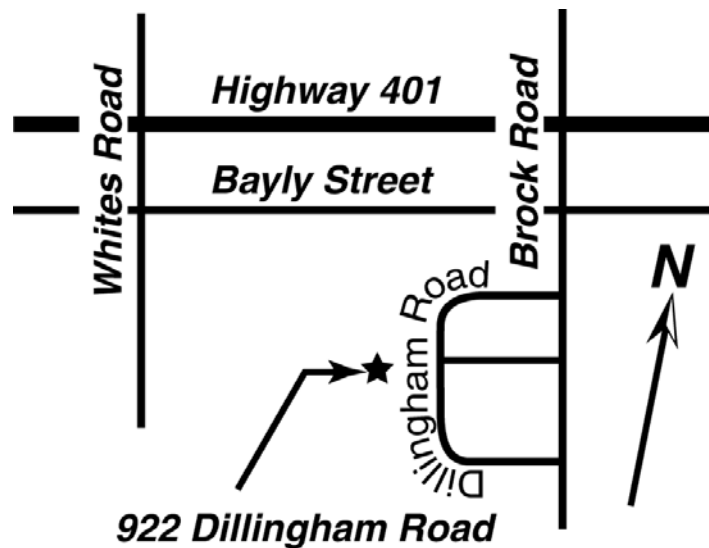

922 Dillingham Road, Pickering, ON L1W 1Z6



Triden Distributors Limited accepts AMERICAN EXPRESS, MASTERCARD and VISA.

TABLE OF CONTENTS

Section	Page No.
Metric Conversion and Glossary of Terms	4
Quick-Guide - A Cutaway Chair.....	5
Adhesives and Aerosols.....	6 - 11
Button Moulds.....	12 - 14
Fasteners	15 - 17
Velcro®	19
Zipper and Accessories.....	20, 21
Casters	22 - 24
Packaging Materials	25
Featured Product	26
Colorbond Refinisher	27
Glides and Legs	28 - 29
Foams and Fillers	30 - 35
Linings and Deckings	36 - 38
Tools	40 - 45
Button Dies and Machines.....	46, 47
Staplers and Tackers.....	48
Compressors and Accessories, Spray Guns.....	48, 50
Power Tools.....	51
Steamers, Cushion Stuffing Machines.....	52
Grommet Setting Tools	53
Marine Trim	55 - 59
Seaming, Piping and Edging.....	60, 61
Springs, Spring Units and Accessories	62 - 67
Webbing	68
Flexweb, Gimp, Seat Covers.....	69
Staples, Tacks and Nails	70 - 75
Tacking Strip, Cardboard.....	76 - 77
Thread and Twine.....	78 - 80
Auto Trim.....	82 - 89
Index.....	90, 91

METRIC CONVERSION

DECIMAL EQUIVALENTS

1/64	=	.015625
1/32	=	.03125
1/16	=	.0625
1/8	=	.125
3/16	=	.1875
1/4	=	.25
5/16	=	.3125
3/8	=	.375
7/16	=	.4375
1/2	=	.5
9/16	=	.5625
5/8	=	.625
11/16	=	.6875
3/4	=	.75
13/16	=	.8125
7/8	=	.875
15/16	=	.9375

IMPERIAL TO METRIC

LENGTH		
1 inch	=	2.54 centimetres
1 sq. inch	=	6.4516 sq. centimetres
1 foot	=	30.48 centimetres
1 sq. foot	=	929.00 sq. centimetres
1 yard	=	0.9144 metres
1 sq. yard	=	.836 sq. metres
VOLUME (Liquid)		
1 ounce	=	28.413 millilitres
1 pint	=	0.56826 litres
1 quart (40 oz)	=	1.13652 litres
1 imperial gallon	=	4.546 litres
WEIGHT		
1 ounce	=	28.35 grams
1 pound	=	0.4536 kilograms

METRIC TO IMPERIAL

LENGTH		
1 millimetre	=	0.03937 inches
1 sq. millimetre	=	0.00155 sq. inches
1 centimetre	=	0.3937 inches
1 sq. centimetre	=	0.155 sq. inches
1 metre	=	39.37 inches
1 sq. metre	=	1.196 sq. yards
VOLUME (Liquid)		
1 millilitre	=	0.035196 ounces
1 litre	=	35.196 ounces
1 litre	=	0.88 quarts
1 hectolitre	=	21.9969 gallons
WEIGHT		
1 gram	=	0.0353 ounces
1 kilogram	=	2.2046 pounds

GLOSSARY - TERMS AND DEFINITIONS • QUICK GUIDE

ACRYLIC - synthetic fiber to make yarn. When solution dyed, will not fade in the sun.

CELLULOSE - natural carbohydrate polymer - raw material for rayon and acetate fibres.

DACRON - DuPont registered trade name for polyester fibre.

DELRIN - DuPont registered trademark for high quality engineered plastic, used in Marine Zipper

GAUGE - in Metal or Diameter of Wire, the higher the number, the smaller or thinner the diameter or thickness. - in Clear Plastic expression of thickness in thousands of an inch. eg. 12 Gauge = 1/12,000 of an inch, or .012 in.

GROSS - term refers to a physical count, equalling 144 items.

JUTE - coarse brown fibre from India used to make Hessian, webbing and twine.

NEEDLE PUNCHED - manufacturing process whereby fibrous material is binded by piercing it rapidly with multiple needles.

OUNCE WEIGHT - of fabric. The actual weight of a Square Yard of material.

POLYETHYLENE - a polymer of ethylene, principally used in injection moulding.

POLYURETHANE - principal ingredient in manufacture of foam. (It is no longer Rubber).

P.V.C. - Polyvinyl Chloride. The main ingredient of vinyl coated fabrics.

RAYON - a manmade fibre of regenerated cellulose used to make a wide range of durable fabrics.





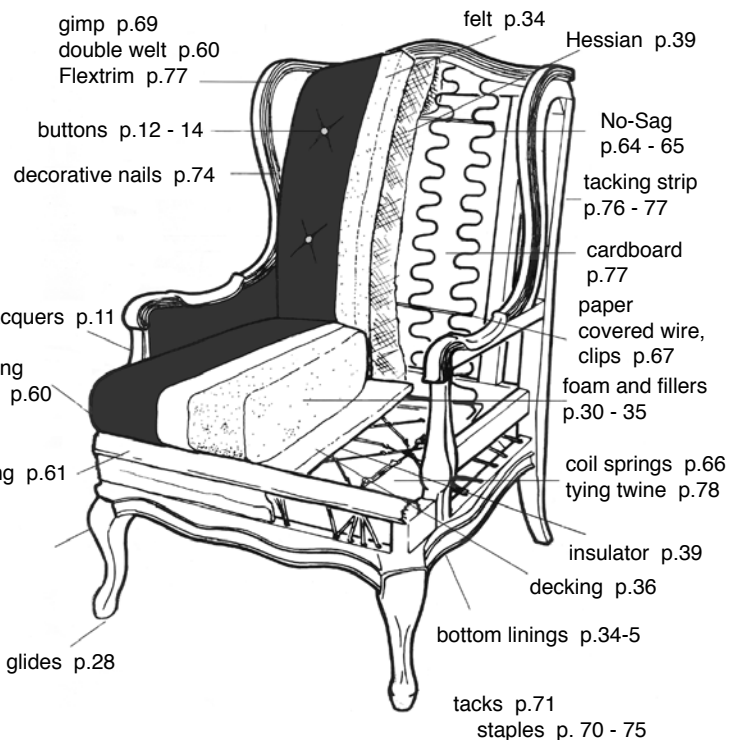





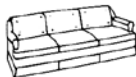
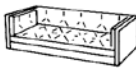



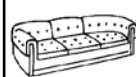

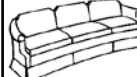

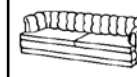

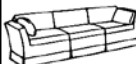



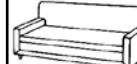

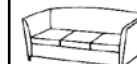
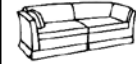





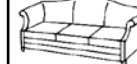
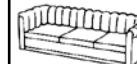



















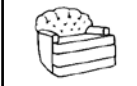















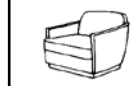

U.V. - ultra violet treated. Refers to protection added to materials that will be used in the outdoors, that need protection from the sun's harmful rays.

VISLON - YKK name for Delrin II, a newer form of Delrin engineered plastic used in zipper.









YARDAGE GUIDE

Simply select the style of chair that you are covering. The amount of fabric suggested is indicated below each drawing.





				 10 YDS	 11 YDS	 10 YDS	 10 YDS
 10 YDS	 12 YDS	 10 YDS	 16 YDS	 12 YDS	 10 YDS	 12 YDS	 12 YDS
 12 YDS	 9 YDS	 9 YDS	 12 YDS	 7 YDS	 9 YDS	 10 YDS	 10 YDS
 10 YDS	 7 YDS	 8 YDS	 6 YDS	 10 YDS	 6 YDS	 10 YDS	 12 YDS
 8 YDS	 7 YDS	 12 YDS	 5 YDS	 6 YDS	 6 YDS	 5 YDS	 5 YDS
 6 YDS	 6 YDS	 4 YDS	 5 YDS	 4 YDS	 4 YDS	 4 YDS	 5 YDS
 5 YDS	 6 YDS	 5 YDS	 5 YDS	 6 YDS	 5 YDS	 6 YDS	 5 YDS
 6 YDS	 5 YDS	 5 YDS	 6 YDS	 5 YDS	 5 YDS	 5 YDS	 4 YDS
 5 YDS	 5 YDS	 5 YDS	 6 YDS	 5 YDS	 6 YDS	 6 YDS	 5 YDS
 5 YDS	 3 YDS	 4 YDS	 1 YDS	 3 YDS	 4 YDS	 3 YDS	 3 YDS



ADHESIVES and AEROSOLS

	Description	Recommended Solvent	Item No.
	<p>Sluyter 478 Foam and Fabric Cement</p> <ul style="list-style-type: none"> • Reformulated to produce a finer spray • cements foam to foam, or foam to wood, metal or cloth • provides a very fast tack and is soft-seaming • for clean-up use solvent 10642 • NON-FLAMMABLE 	SL-1	<p>10608 - 4 litre tin - clear 10602 - 4 litre tin - green 10600 - 20 litre pail - clear 10607 - 20 litre pail - green</p>
	<p>HELTITIN C 1535 Foam and Fabric Cement</p> <ul style="list-style-type: none"> • fast drying, soft seam fabricating cement • exceptional sprayability, aggressive tack • excellent for foam to foam, foam to wood or metal • available in clear or pink for high visibility • for clean-up use solvent 10642 • NON-FLAMMABLE 	SL-1	<p>10629 - 18.9 litre pail - clear 10635 - 18.9 litre pail - pink</p>
	<p>Zytek 72107 Foam and Fabric Red Cement</p> <ul style="list-style-type: none"> • economical, sprayable foam cement • for clean-up use acetone • FLAMMABLE 	SL-1	10658 - 18.9 litre pail - red
	<p>Sluyter 350 Foam Adhesive</p> <ul style="list-style-type: none"> • cement 350 green foam / fabric • FLAMMABLE 	SL-1	10609 - 4 litre tin - green
	<p>Contact Adhesive CP 2056</p> <ul style="list-style-type: none"> • trimmer's cement • fast tacking contact trim cement, Neoprene based. • FLAMMABLE 	SL-1	<p>10652 - 950 ml. can 10613 - 20 litre pail</p>
	<p>Primabond CA 8075 Contact Cement</p> <ul style="list-style-type: none"> • for vinyl to vinyl applications • also bonds ABS, rubber, metals, ceramics, leather, canvas, fabric and other synthetic materials • cures to a clear, tough and flexible film with good heat resistance • has exceptional resistance to plasticizers and oils • FLAMMABLE 	SL-1	10672 - 950 ml. can





Or try cleaner 25-SL2

ADHESIVES and AEROSOLS

Description		Item No.
	<p>Helmitin General Purpose Adhesive</p> <ul style="list-style-type: none"> • bonds foam and fabric to wood and themselves • instant tacking • controlled lace spray gives strong bonds • non-flammable 	10628 - 17 ounce
	<p>Bostik SuperTak High Performance Aerosol Adhesive</p> <ul style="list-style-type: none"> • forms strong one surface bonds • permanent bonds between porous and nonporous surfaces • adheres to metal and most plastics • 3 way variable nozzle • does not contain methylene chloride or ozone depleting chemicals • Bostik Product #150724 	10655 - 17 ounce tin
	<p>Sluyter 470 Featherspray</p> <ul style="list-style-type: none"> • aerosol foam fabricating cement • bonds foam to foam, or to wood, metal or glass • unique spray pattern ensures total coverage 	10644 - 375 gram tin - Clear 10646 - 375 gram tin - Yellow
	<p>Easy Stik 504 Latex Cement</p> <ul style="list-style-type: none"> • bonds gimp to fabric, fabric to fabric and foams • water resistant glue 	10648 - 500 ml. squeeze bottle

Code	Solvents	Item No.
 SL-1	Cleaner 21 - Toulene	10640 - 4 litre
 SL-2	Cleaner 25 - All Purpose Dimethyl Ethyl Chloride	10643 - 4 litre
 SL-3	Acetone - Flammable Style Solvent	12075 - 4 litre

ADHESIVES & AEROSOLS • AUTO TRIM CEMENTS

	Description	Item No.
	<p>Helmitin 4510 Landau Contact Trim Cement</p> <ul style="list-style-type: none"> • slow tacking helps so you can reposition the top until it is ready to set. • also used for carpet installation and general trim work • for clean-up use solvent 10642 • NON-FLAMMABLE 	<p>10661 - 18.9 litre pail - clear</p>
	<p>Sluyter 390 Hi Temp Adhesive</p> <ul style="list-style-type: none"> • pink - auto and marine • Uses: fabric, leather, vinyl, laminate wood along with most rubbers and plastics • resists temperatures over 194F (90c) with soft glue line and rapid drying 	<p>10622 - 4 litre pail</p>
	<p>Fast Tack 92 Hi-Temp Aerosol Adhesive</p> <ul style="list-style-type: none"> • for high temperature, heavy-duty bonding of headliners, vinyl tops etc. • easily bonds heavier weight material to metals, wood and plastic • excellent heat and water resistance • FLAMMABLE 	<p>10650 - 13 ounce can</p>
	<p>DAP Landau 233 Contact Trim Adhesive Cement</p> <p>Spray contact bulk trim adhesive especially formulated for our trade! HIGH heat resistance, easy to work with, applies evenly and provides a superior bond. Use on vinyl, carpet, and headlining to metal, fibreboard or other substrates. Non flammable, DAP Landau 233 Trim Contact Cement is easy to spray without diluent. Also use on leather, cloth, laminates, wood veneers and other common trim components. Natural appearance, no dyes added.</p>	<p>10625 - 1 US gallon</p>

WATCH FOR AND KNOW THESE LABELS



**FLAMMABLE
AND
COMBUSTIBLE**



**TOXIC EFFECTS
(IMMEDIATE)**



**TOXIC EFFECTS
(OTHER)**

Workplace Hazardous Materials Information System (WHMIS)

Legislation has been put in force regarding WHMIS. As your supplier, we do our part by making a Material Safety Data Sheet (or MSDS) available to you for each controlled product that you may use.

You in turn relay that information to the employees that work with the substances.







The MSDS has important information regarding controlled substances, their physical properties, health considerations, storage and safety precautions. We supply a current MSDS with all of the designated substances that are described on these pages. Consult your provincial government for more information regarding WHMIS.

Always use common sense when handling any potentially hazardous product.



Doing our part for a safer environment

To inquire about an MSDS send us an e-mail: tridenmsds@gmail.com

CLEANERS & PROTECTORS

	Description	Item No.
	<p>Spot Off Dry Cleaner</p> <ul style="list-style-type: none"> • solvent based • all purpose stain remover for fabric, suede and smooth leather • try the convenient aerosol 	<p>10696 - 110 ml bottle 10695 - 400 gram aerosol 10698 - 4 Litre can</p>
	<p>Super-Tuff Cleaner</p> <ul style="list-style-type: none"> • concentrated all purpose cleaner and degreaser. • removes mildew instantly, safe on most washable surfaces. • bio-degradable and non-toxic. • dilute with water @ 4:1 for a great degreaser • dilute with water @ 20:1 for a general cleaner • NON-FLAMMABLE 	<p>12039 - 32 ounce bottle</p>
	<p>Klear-To-Sea Protectant</p> <ul style="list-style-type: none"> • cleaner and preservative for use on clear vinyl, plexiglass and Lexan. • easy to use pump spray repairs light scratches. • anti-fog, anti-static and reduces glare. 	<p>12038 - 16 ounce pump spray</p>
	<p>LEATHER-CARE Vinyl and Leather Cleaner & Conditioner</p> <ul style="list-style-type: none"> • restores colour and lustre to soiled leather and vinyl finishes. • foaming action penetrates quickly to remove dirt and grime. • safe for all your leather and vinyl upholstery. 	<p>10697 - 396 gram aerosol</p>
	<p>303 Vinyl Conditioner and U.V. Protectant</p> <ul style="list-style-type: none"> • water based - truly effective • no silicone to destroy plasticizer • ask for your FREE SAMPLE 	<p>12033 - 8 ounce spray 12034 - 16 ounce spray 12035 - 32 ounce bottle 12036 - 1 US gallon</p>
	<p>Wrinkle Remover</p> <ul style="list-style-type: none"> • removes wrinkles and tack pulls on completed upholstered items. • spray on and watch wrinkles disappear 	<p>15670 - 1 Litre Bottle w/Sprayer 15671 - 4 Litre Jug</p>
	<p>Aqua Tite Top Gun Sealer</p> <ul style="list-style-type: none"> • 10 % silicone based - great for seams, high wear points • Non Flammable. Will not affect FR rating if used. • recommended for polyester tops like Top Gun and Odyssey • * do not use if product turns "milkey" in storage 	<p>12031 - 32 ounce spray bottle 12030 - 1 U.S. gallon (3.785L)</p>

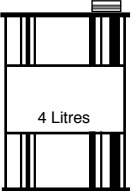
SILICONE

SILICONE: <ul style="list-style-type: none"> • makes cushion stuffing easier • colourless • dries instantly • non-toxic • non-flammable 			
Size Available	400 gm. Aerosol	4 Litre Jug	20 Litre Pail
Bonaventure Brand Silicone	12057	-	-
• our most value-priced spray			
Super Slip	12054	12070	12074
• great for use on machinery			
Easy Slip	12050	12060	-
• ideal for lubricating cutting table surfaces			
• will not affect most fabrics			
Grip-Slip	12052	-	-
• paintable Silicone spray			
• eliminates "fish eyes" when you use lacquer spray in the same building			
• great for wood working shops			

FABRIC TREATMENT



Economical Fabrigard® Protector

- effective against oil based and other troublesome stains.
- spray bulk product with our #118 gun.

300 gm. Aerosol Item No. 12080

4 Litre Pail Item No. 12084

20 Litre Pail Item No. 12086



303 High Tech Fabric Guard

- pump spray or bulk for convenient spraying
- do not over soak - 2 light coats are ideal
- also provides U.V. protection
- the ONLY product approved by Glen Raven

16 oz. trigger pump Item No. 12032

32 oz. trigger pump Item No. 12040

1 gallon pail Item No. 12037

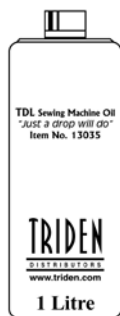

Sewing Machine Oil

- light weight oil specifically made for sewing machines
- use sparingly - but frequently - to keep your machine running smoothly
- 1 Litre bottle

Item No. 13035

JET SPRAY LACQUERS & FINISHES

Especially formulated to enable the experienced as well as the novice to do a professional job. Unfinished and finished wooden arms, legs, scuffed and rubbed through areas can be finished with ease by simply applying the desired shade.

If a more durable lasting finish is required, follow up with an application of Sealer and complete with clear lacquer in the desired sheen (gloss, satin or flat). This product is economical, easily applied and dries quickly. The finish is alcohol resistant.

13 fluid ounces in convenient aerosol spray bombs.



BROWN MAHOGANY
#832
Item No. 11985



BURNT UMBER
#818
Item No. 12002



CHERRY
#858
Item No. 11990



DARK AMERICAN WALNUT
#809
Item No. 11976



DARK MAHOGANY
#831
Item No. 11988



EXTRA DARK WALNUT
#850
Item No. 11978



GOLDEN OAK
#815
Item No. 11993



LIGHT FRUITWOOD
#L854
Item No. 12005



MAPLE
#892
Item No. 11991



MEDIUM BROWN WALNUT
#853
Item No. 11980



MEDIUM MAHOGANY
#829
Item No. 11986



MEDIUM OAK
#822
Item No. 12001



NATURAL
#813
Item No. 12007



RAW UMBER
#817
Item No. 12003



RED MAHOGANY
#873
Item No. 11989



VAN DYKE BROWN
#878
Item No. 11999

Also Available:

BLACK

Flat #F 826
Gloss #G 826
Satin #S 826

Item No. 12010
Item No. 12008
Item No. 11987

CLEAR LACQUER

Gloss #800
Satin #801
Flat #802

Item No. 11960
Item No. 11962
Item No. 11964

WHITE

Gloss #G 804

Item No. 11966

Blush Eraser #871

Sanding Sealer #803

Item No. 11971
Item No. 11968

BUTTONS by HANDY

Our button parts or moulds are made of the very highest quality stock. As the major Handy dealer in Canada we are committed to the Plan for Excellence in ensuring your buttons turn out perfect first time - every time.

Call us if you have any questions regarding your custom button manufacturing.

We aim to serve!

SHELLS

There are 5 stock button sizes for upholstery applications

Shown actual size



#36 Shell

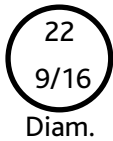

22
9/16
Diam.

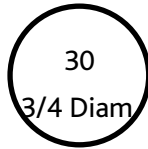

30
3/4 Diam.

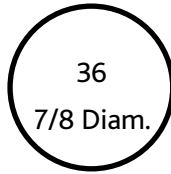

36
7/8 Diam.

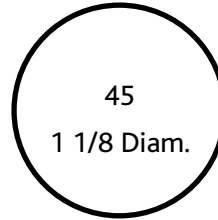

45
1 1/8 Diam.

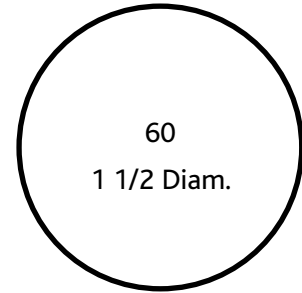

60
1 1/2 Diam.

SHELLS COME IN THREE GRADES

Regular	Heavier material, uneven fabric The first choice for most applications
Soft	Use for expanded vinyls. You may need a softer tempered shell to avoid tearing or cutting, especially with thin or delicate material.
Rust Resistant	Special chromate plating resists rust up to five times longer than regular shells.

TO ORDER:

Complete sets of button moulds (shells and backs) are packaged in 5 gross or 25 gross boxes. For your convenience, you can also mix or match shells and backs, or purchase separate pieces, as you require.

Order in one, five or twenty five gross packages. You can order using the ITEM NUMBER on the pages that follow, or order by the description of the button parts you need. IT'S YOUR CHOICE!

SHELLS

Size	Regular	Soft	Rust Resistant
22	N/A	10212	10211
30	N/A	10216	10217
36	N/A	10220	10219
45	N/A	10224	COL411
60	10226	N/A	10225

S/O - Special Order - 5 gross minimum

N/A - Not Available

BACKS

Size	No. 9 Wire Eye	No. 44 Loop	Nylon Hook
22	10240	10242	10280
30	10246	10248	10282
36	10252	10254	10284
45	10258	N/A	10286
60	10264	N/A	N/A

N/A - Not Available



No.9 Wire Eye



No.44 Loop



Nylon Hook

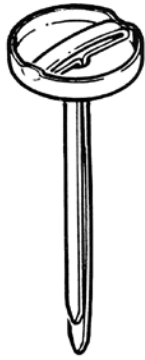

Prong Backs

Use Prongs for fast button tufting instead of hand tying.

Length	Button Size			
	22	30	36	45
1 1/2"	10320	10326	10332	S/O
2"	10322	10328	10334	10340
2 1/2"	10324	10330	10336	S/O

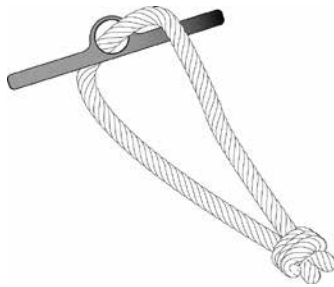

"Fastuft" Machine Tied Tufting Loops

- for permanent tufting in tight seat backs and non-reversible cushions
- produces a secure, uniform tuft
- 5,000 to a box

Length	1 5/8"	2"	2 1/2"	2 3/4"	3"
Item No.	10341	10342	10345	10343	10344

Also available: Ejector Needle Lever Style - Item No. 14183



8402 Pre-Tied Tufting Loops

- use 8402 Pre-tied loops for tufting.
- loops are available in a variety of stock sizes to make all of your tufting jobs easier.
- all loops are 5,000 to a box.

Length	1"	2"	2 1/2"	3"	3 1/2"	4"	4 1/2"	9"
Item No.	10359	10368	10361	10362	10363	10364	10365	10367

Supertwist Button Tufting Twine

- 80 lb. breaking strength
- 2,200 feet per pound
- 1" core
- 100% nylon

One Pound Item No. 15346

Two Pound Item No. 15348

BUTTONS by HANDY

WASHERS



28 Split Retainer

- 2000 per box
- NSB 100



#1 Washer

- for all size prongs
- Item No. 10309



#9 Plastic Slot

- use with pretied loops
- Item No. 10304



#15 Spring Lock Washer

- for threaded nail applications
- Item No. 10302

Single Pivot

- when decorating skirts, use a one sided covered button and a 5/16" tack back.
- 30 or 36 Ligne sizes

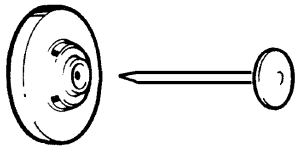

5/16" Tack
Item No. 10352

#30 Female Back Pivot Tack #36 Female Back
Item No. 10348 Item No. 10349

Double Pivot

- button to button use, attaching padded cane
- chair backs or buttoning throw cushions.

FEMALE BACK
(SEE LEFT
TO ORDER)

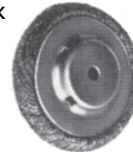

#30 Female Back
Item No. 10348
(shown)



MALE BACK

#30 Male 5/8" Back
Item No. 10357

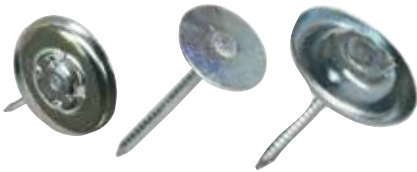

Description	Item No.
Pivot Back Male 36 1/2	10318
Pivot Tack 3/4	10353
36 Threaded Nail 7/8	10278

SPECIAL APPLICATIONS

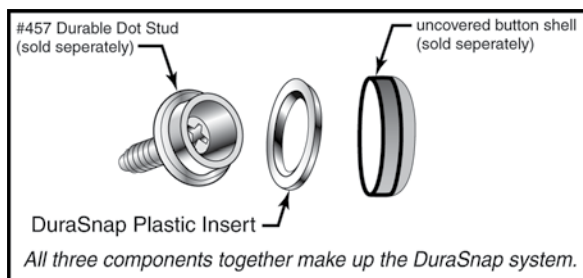

DuraSnap Button System

Make the button in the usual way, except instead of a regular button back, use the DuraSnap plastic back in it's place.

Then, just snap the finished covered button, complete with the DuraSnap plastic back, over a Durable Dot™ stud completing the job!

Fits a #30 shell Item No. 10294

Fits a #36 shell Item No. 10296

No Dent Nails

Heavy steel backs are stamped and formed to support shell and prevent denting. Match with the correct shell and you have an easy to apply, attractive button for such things as bars, heavy wooden pieces, etc

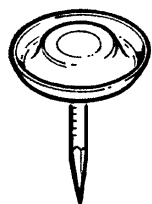

Size	22	30	36	45
Item No.	10270	10272	10274	10276

#40 Half Ball Button

A finished plastic button for outdoor furniture.

Great with our own Textilene Patio Fabric.

White Item No. 10310

Cream Item No. 10312

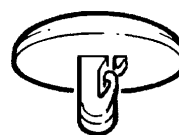











Snap Fasteners

All nickel plated on brass unless otherwise indicated

For Setting these Snap Fasteners, See the Press-N-Snap Tool on page 84

Snap Fasteners are 24 Lignes, Baby fasteners are 20 Ligne size. There are 40 Lignes to an inch.

Type	Remarks	Finish	Item No.	
670 Cap	1/4" Barrel	"K-Mane" Brand	11010	 Cap
S 670	1/4" Barrel	nickel plate on steel	11038	
SS 670		stainless steel	11106	
670L	5/16" Barrel		11012	
670L	5/16" Barrel	black	11021	
Baby 53	1/4" Barrel		11046	
670B	1/4" Barrel	black enamel on brass	11011	
M548 Socket	regular action		11013	 Socket
T548	hard action	nickel plate on steel	11015	
SC548	furniture applications	stainless steel	11040	
SS 548			11107	
Baby 63			11048	
550 Stud	use screw, rivet or eyelet		11016	 Stud
S550		nickel plate on steel	11042	
SS 550		stainless steel	11108	
Baby 82			11050	
550A Eyelet	1/4"		11018	 Eyelet
550B	5/16"		11020	
S550A	1/4"	nickel plate on steel	11044	
SS 550A		stainless steel	11109	
Baby 82B	3/16"		11052	
#457 Screw Stud	3/8" #7 Robertson Screw 5/8" Robertson 3/8" Phillips 5/8" Phillips 7/16" Phillips	nickel plated brass with stainless steel screw	11026 11025 11022 11024 11029	 Screw Stud
#552 Long Barrel Double Stud	Gypsy Stud for reversible combination	nickel plate on brass	11039	 Double Stud
#559 Machine Screw	Phillips 10/32" x 5/8"	steel machine screw	11028	 Machine Screw
#373 Flangeless Stud	same as 559 without screw	nickel plate on brass	11017	 Flangeless Stud
#22036 Windshield Clip	Fits 3/4" channel	nickel plate on brass	11031	 Snap Fastener Type
	Fits 7/8" channel	nickel plate on brass	11037	
Windshield Clip for L.T.D.	Fits 7/8" channel	nickel plate on brass	11041	 L.T.D. Fastener Type

670 Caps available in colours to match **TOP GUN** marine topping.

Aquamarine, Dark Burgundy, Forest Green, Off White, Pacific Blue, Teal Green, Toast

FASTENERS

Common Sense™ Fasteners

- nickel plated brass • positive locking
- setting tools and cutters on page 84

Name	Model	Item No.
Stud	401 single	11060
	402 double	11062
	404 single, wood screw	11063
	410 single, clinch type	11064
Eyelet	400	11066
	400L for thicker material	11067
Washer	400A for eyelet	11068
	400B more secure & faster	11069
	410A for #410 clinch type stud	11070

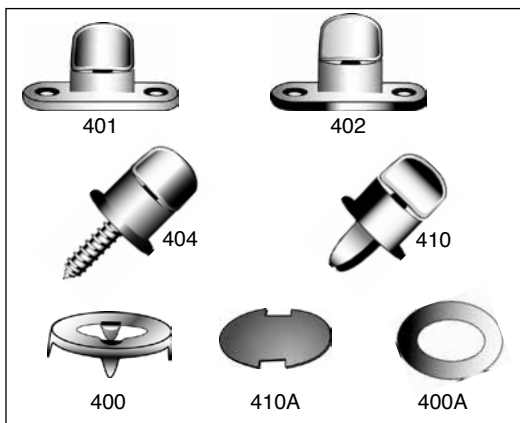

Nylon Permalock™ Fasteners

- made of acetyl plastic
- will not corrode, rust or tarnish
- ideal for winter applications
- -40° C cold crack

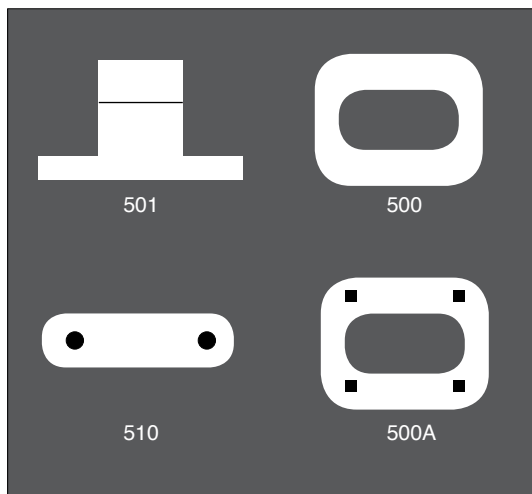

Name	White	Black
501 Stud	11076	11074
500 Eyelet	11080	11078
500A Washer	11084	11082
510 Washer	11088	11086

Hand Setting Dies for #510 Item No. 14252

Punch for #500 Item No. 14250

Stayput Fastening System

- made of glass filled nylon
- unaffected by U.V. rays or freezing
- no springs to corrode or jam
- all pieces available in **Black** or **White**



- snap **Back Clip** through 1/4" hole in fabric to secure to clip
- clip may now fasten fabric securely to either **Post** or **Hook**

Black Item No. 43003

White Item No. 43006



- attach to fabric with back clip or fastened to gelcoat or other solid surface

Black Item No. 43004

White Item No. 43007

- attaches to solid surface to secure cover

Black Item No. 43005

White Item No. 43008



Stay-Put "J" Hook

- "J" hook attaches to Stay-put shockcord clip (not included) - attaches to lifelines on inflatables

Black Item No. 43023

LIFT THE DOT® Fasteners

The standard in restoring British sports cars, antique boats, where canvas and hard surfaces meet. Nickel plated brass.

Type	Remarks	Item No.
852	Single Stud, Hex Base 3/8" wood screw	11097
852	Single Stud, Hex Base 1/2" wood screw	11096
882	Machine Screw #10 - 32 x 3/8"	11104
895	Single Stud two prong clinch	11100
295A	Washer for 895	11102
608	Socket - Bronze spring	11092
708A	Clinch Plate for Socket	11094

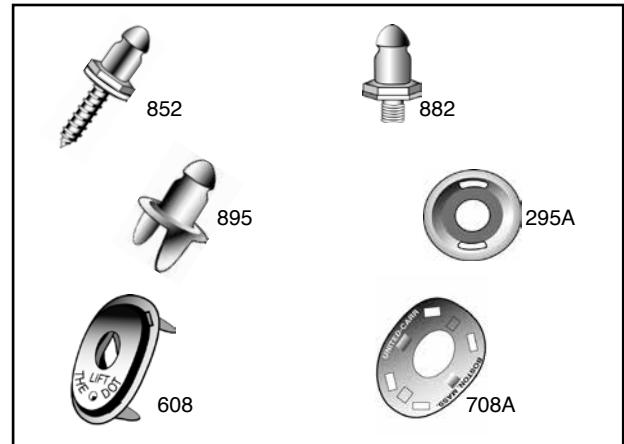

Pull the Dot™ Locking type Fasteners





When set, shows the direction to pull for release

Type	Remarks	Finish	Item No.
181	11/16" Barrel	nickel plated brass	11032
182	single direction socket	nickel plated brass	11034
183	hex base stud	nickel plated brass	11036
Note: Socket Die for Press 'N Snap			14257



Stainless Steel Snap Fasteners

- when used correctly, will not rust or corrode
- ideal for salt water

Type	Part Name	Item No.	
SS 670	Cap	11106	
SS 548	Socket	11107	
SS 550	Stud	11108	
SS 550A	Eyelet	11109	



Snap Caps

- coloured plastic cap fits over screw for a finished look. 2 piece construction ensures reliability
- package size 100 pieces

Black Item No. 12502

White Item No. 12504

Also available in Aluminium, Blue, Cream, Mahogany and Silver.

FASTENERS

Sheet Grommets and Washers

- gilt brass packaged in 100's and 1000's
- other sizes available

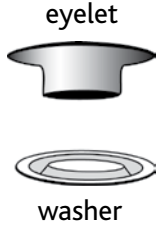

Size		0	1	2	3	4
Hole Diameter when set		1/4"	5/16"	3/8"	7/16"	3/8"
Item No.	Eyelet	11840	11842	11844	11850	11848
	Washer	11841	11843	11845	11851	11849



216 Grommet Setting Tool

- dropped forge steel
- 2 piece punch and die set

Type	0	1	2	3	4
Sheet	14072	14074	14076	14078	14081
Spur	-	-	14075	14077	14083

No. 216

**Nickel Grommets
Also Available**

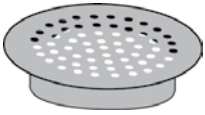

Brass Ventilator

- 3/4" dia; 3/16" shank
- sold in 100's or 1000's

Brass Ventilators Item No. 11854

Steel Washer Item No. 11855

Ventilator Setting Tool # 621

- 3/4" - fits our stock ventilators
- 2 piece

Item No. 14090

Vent Hole Punch

Item No. 14059

Ventilator Dies

- for use with Handy # 1 Button Machine
- includes long cutter

Item No. 14086

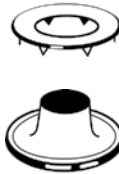

Spur Grommets (Teeth Type)

- with rolled edge washer

Size	2	3	4
Hole Dia.	7/16"	15/32"	5/8"
Eyelet	11832	11834	11836
Washer	11833	11835	11837

D Ring

1/2" Item No. 10293

3/4" Item No. 10985

Snap Hook with retainer

1/2" Item No. 10297

Snap Hook no retainer

3/4" Item No. 10984



No. 621



Eye Snap



Use our 1/2" elastic and snap hook to secure cushions.

Description	White	Black
1/2" elastic, 144 yards	10980	10979
1" in 50 meter roll	10982	10981

Klinch It Fasteners

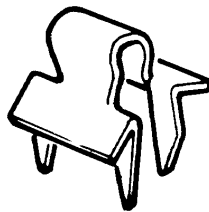

To fasten coil springs to webbing

5000 to a box - Item No. 11920

Knobby Twist Pin



500 to a box Item No. 11926

100 to a box Item No. 11927

The practical fastener for practically anything. Applications are limited only by your imagination. Flame Retardant.

To order, just tell us the width, type, style and length - either by the yard or in convenient 25 yard rolls.

Use the chart below.

		Regular Backing		Pressure Sensitive Adhesive Type Backing	
Width	Type	Black	White	Black	White
18mm - (3/4")	Hook	15400	15404	15440	15444
	Loop	15402	15406	15442	15446
25mm - (1")	Hook	15410	15414	15450	15454
	Loop	15412	15416	15452	15456
50mm - (2")	Hook	15420	15424	15457	15460
	Loop	15422	15426	15458	15459
100mm - (4")	Hook	15396	15427	15386	-
	Loop	15395	15428	15389	-

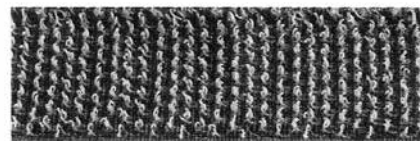

Hook

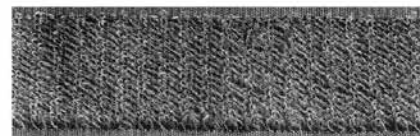

Loop

All adhesive backed Velcro should be allowed a minimum 24 hours to "set up" or bond properly before stress is applied.

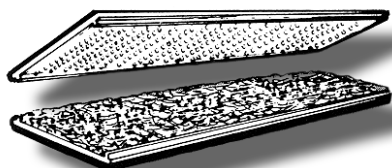

VELSTICK® Rigid Plastic Drapery System

- vinyl extrusion strips with VELCRO® hook or loop attached
- attaches to most rigid surfaces by stapling, screwing or nailing
- 1 metre length, 25 mm (1") VELCRO®

Black Hook Item No. 15471 White Hook Item No. 15473

Black Loop Item No. 15472 White Loop Item No. 15474

**Call for Your
Specialized Application.
Let Us Help**

VELCRO® "One-Wrap"

- hook and loop front to back
- sold by the roll only (25 yards)

Black - 3/4" Item No. 15378

Black - 1" Item No. 15383

VELCRO® "Soft Sew"

- soft backed Velcro® makes sewing easier

• 1 5/8" wide, White

- sold by the yard

Item No. 15462

VELCOINS®

Velcoins® are convenient and easy to use. Each "coin" comes in both hook and pile on pressure sensitive adhesive type backing. Simply peel off and stick to mating surfaces and you are done! Stocked in Black and White.

Colours are available by special order.

1/2" Velcoins® are 1440 per roll	
White Hook	15430
White Loop	15431
Black Hook	15432
Black Loop	15433

3/4" Velcoins® are 1028 per roll	
White Hook	15466
White Loop	15467
Black Hook	15468
Black Loop	15469

7/8" Velcoins® are 900 per roll	
White Hook	15475
White Loop	15476
Black Hook	15477
Black Loop	15478

ZIPPER

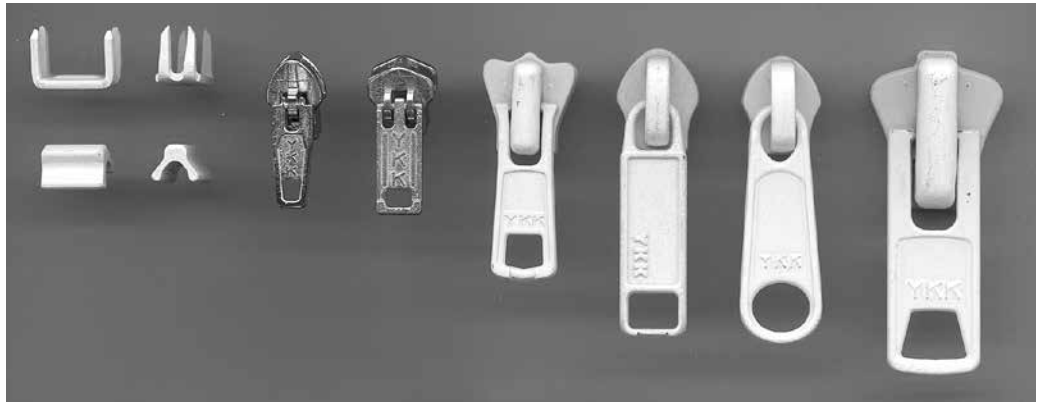

Depicted from left to right
Top Stop and Bottom Stops, Sliders; numbers #2SF, #4, #5, #5 with luggage tab, RT 100, #10.

Coil type Zipper

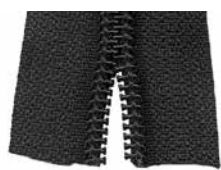

A COIL type zipper is made up of a continuous single strand of material that loops through the tape.

Size	Type	Finish	Single Tab	Double Tab (Locking)	Luggage Tab	
					Single Tab	Double Tab
2SF	Coil	Nickel	15962	-	-	-
RT100	Coil	White	15982	-	15981	-
RT100	Coil	Black	15979	15986	15984	-
5	Tooth	White	16087	16089	-	-
5	Tooth	Black	16093	16092	-	-
8	Coil	Nickel	-	-	16114	-
10	Coil	Black	16103	-	-	-
10	Coil	Nickel	-	16101	-	-
10	Coil	Black	16103	16096 Non-Locking	-	-
10	Tooth	White	16102	16104	-	-
10	Tooth	Black	16109	16110	-	-

Tooth type Zipper



A TOOTH zipper has individual elements attached to the tape.

Sliders		
Size	Aluminum	Brass
4	15894	15709
5 Single Tab	15920	15806
5 Double Tab	15922	15808

Speciality Zipper - A GREAT BUY		
Size	17"	25"
#5 Coil Black	16558	16559
Separating with slider + steps		

Top Stops			
Size	Aluminum	Brass	Delrin (Black)
4	-	15710	-
5	15924	15810	16094
Bottom Stops			
4	-	15712	-
5	15926	15812	16091

ZIPPER CHAIN

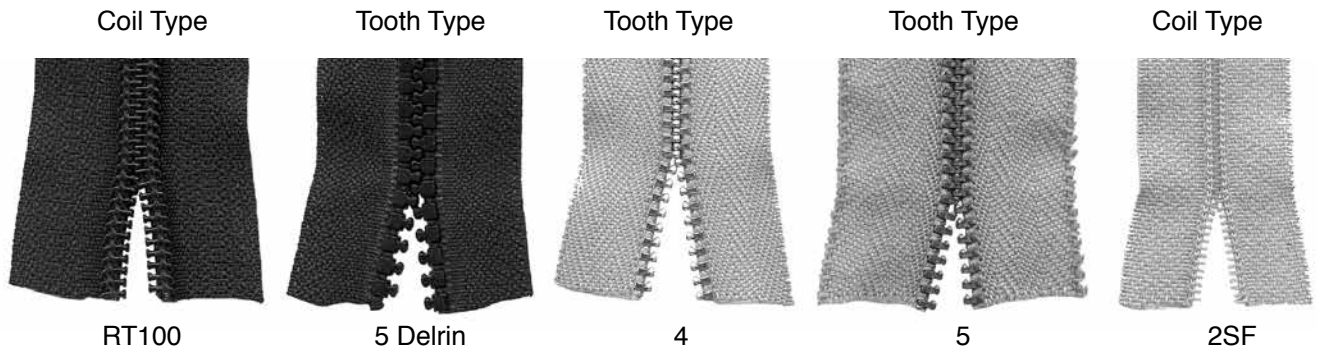

Aluminum Zipper Chain					
No.	Type	Tape Colour	Tape Width (one side)	Put Up (yards)	Item No.
4	Tooth	Natural	7/16"	273	15890
4	Tooth	Black	5/8"	150	15910
5	Tooth	White	5/8"	109	15914

Brass Zipper Chain					
No.	Type	Tape Colour	Tape Width (one side)	Put Up (yards)	Item No.
4	Tooth	Beige	1/2"	164	15703
5	Tooth	Black	5/8"	150	15802

Delrin Zipper



Aluminum Zipper

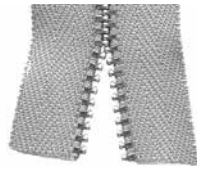

Delrin Zipper Chain					
No.	Type	Tape Colour	Tape Width (one side)	Put Up (yards)	Item No.
5	Tooth	White	9/16"	218	16088
5	Tooth	Black	9/16"	218	16090
10	Tooth	White	5/8"	109	16100
10	Tooth	Black	5/8"	109	16108

Brass Zipper

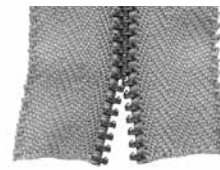

Nylon Zipper



Nylon Zipper Chain					
No.	Type	Tape Colour	Tape Width (one side)	Put Up (yards)	Item No.
2SF	Coil	White	7/16"	273	15960
2SF	Coil	Black	7/16"	273	15966
2SF	Coil	Beige	7/16"	273	15959
RT100	Coil	White	5/8"	218	15980
RT100	Coil	Black	5/8"	218	15983
8	Coil	Black	3/4"	164	15970
8	Coil	Tan	3/4"	164	16113
10	Coil	White	3/4"	218	16099
10	Coil	Black	3/4"	218	16095

Order by the yard or a full roll.

CHAIN.....term referring to both sides of tape with teeth attached.

TEETH.....metal or hard synthetic material attached to the tape that interconnect when passed over by a slider.

TAPE.....Twill Tape that holds teeth and is attached to whatever material you are fastening

SLIDER.....device that pulls over both sides of tape to interconnect the teeth, thus closing the fastener.

TAB OR PULL.....the flat piece attached to the slider that you pull to open or close the zipper.

REVERSIBLE TAB.....has two tabs, one on either side to allow you to open zipper from either side, like a tent door.

LUGGAGE TAB.....oversized tab to allow for easy access.

DOUBLE ACTING ZIPPER..... designed for luggage application allowing an enclosure to be opened either side a centre point.

TOP STOP.....to secure slider from leaving the chain; two are fastened on either side of the chain

BOTTOM STOP.....a single piece to secure both sides of the chain at the bottom of the zipper.

CLOSED END ZIPPER.....refers to a finished length zipper, complete with slider, bottom stop and two top stops

SEPARATING ZIPPER.....fixed length of chain with top stops and a starter tooth that fits into a box, so slider may be drawn across the chain to close the zipper, as commonly used in jackets





CASTERS by *shepherd*®

Order your casters in 2 easy steps:

STEP 1: Choose the finish and size of caster you require.

STEP 2: Choose the fitting most appropriate for your application.

(see page 21 for available fittings)

		STEP 1	STEP 2
Product Details		Finish and Item No.	Fitting, Code and item No.
	Saturn (with Rubber Tread) Wheel Diameter: 3" Mounting Height: 3 1/4" Mobility Load per Caster: 100 pounds	Bright Brass 10559 Bright Chrome 10548 Bright Brass w/brake 10547	P-01 Square Plate 10550 P-02 Prong - Wood 10551 P-05 Threaded Stem 10552 P-82 Grip Ring 10553 P-25 Threaded Stem 10554 P-37 Threaded Stem 10555 P-88 Grip Ring 10556
	Planet Wheel Diameter: 2 1/2" Mounting Height: 3" Mobility Load per Caster: 100 pounds	Bright Brass 10541 Bright Chrome 10542 Windsor Antique 10543 Bright Brass w/brake 10544	P-01 Square Plate 10550 P-02 Prong - Wood 10551 P-05 Threaded Stem 10552 P-82 Grip Ring 10553 P-25 Threaded Stem 10554 P-37 Threaded Stem 10555 P-88 Grip Ring 10556
	Nova (with Rubber Tread) Wheel Diameter: 2 1/4" Mounting Height: 2 5/8" Mobility Load per Caster: 75 pounds	Bright Brass 10565 Bright Chrome 10566	SE-01 Square Plate 10570 SE-02 Prong - Wood 10571 SE-07 Threaded Stem 10572 SE-25 Threaded Stem 10573 SE-37 Threaded Stem 10574 SE-82 Grip Ring 10575 SE-88 Grip Ring 10576
	Satellite Wheel Diameter: 2" Mounting Height: 2 1/2" Mobility Load per Caster: 75 pounds	Bright Brass 10561 Bright Chrome 10562 Windsor Antique 10560	SE-01 Square Plate 10570 SE-02 Prong - Wood 10571 SE-07 Threaded Stem 10572 SE-25 Threaded Stem 10573 SE-37 Threaded Stem 10574 SE-82 Grip Ring 10575 SE-88 Grip Ring 10576

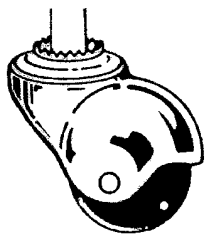

TDL Hooded Ball Type

- light duty domestic caster
- black rubber ball with brass or chrome head
- requires a metal socket - prong type only

Brass Item No. 10632

Chrome Item No. 10630

Also available in Brass with 2" x 1 3/16" plate Item No. 10631



Metal Socket

For prong type casters.

Item No. 10578



TWIN WHEEL CASTERS by *shepherd*®

Order your casters in 2 easy steps:

STEP 1: Choose the finish and size of caster you require.

STEP 2: Choose the fitting most appropriate for your application.

(see bottom of this page for available fittings)

	Product Details	STEP 1		STEP 2		
		Finish and Item No.		Fitting, Code and item No.		
	Pacer 50 Wheel Diameter: 2" Mounting Height: 2 1/4" Mobility Load per Caster: 100 pounds	Black Hood	10546	SE-01	Square Plate	10570
		Chrome Hood	10563	SE-02	Prong - Wood	10571
				SE-07	Threaded Stem	10572
				SE-25	Threaded Stem	10573
				SE-37	Threaded Stem	10574
				SE-82	Grip Ring	10575
				SE-88	Grip Ring	10576
	Pacer 60 Wheel Diameter: 2 3/8" Mounting Height: 2 3/4" Mobility Load per Caster: 100 pounds	Black Hood	10557	P-01	Square Plate	10550
		Chrome Hood	10558	P-02	Prong - Wood	10551
				P-05	Threaded Stem	10552
				P-82	Grip Ring	10553
				P-25	Threaded Stem	10554
				P-37	Threaded Stem	10555
				P-88	Grip Ring	10556
	Pert 52 Economy Twin Wheel Wheel Diameter: 2 1/16" Mounting Height: 2 1/2" Mobility Load per Caster: 75 pounds	Black Hood	10545	SE-01	Square Plate	10570
				SE-02	Prong - Wood	10571
				SE-37	Threaded Stem	10574
				SE-82	Grip Ring	10575
				SE-88	Grip Ring	10576

STOCK FITTINGS FOR *shepherd*® TWIN-WHEEL AND BALL CASTERS



Threaded Stem #05
3/8" x 1 1/2"
Item No. 10552 (P)

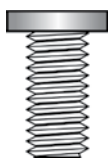

Threaded Stem #37
3/8" x 3/4"
Item No. 10555 (P)
Item No. 10574 (S)

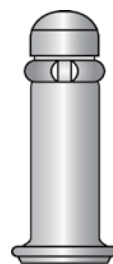

Grip Ring #82
7/16" x 1 7/16"
Item No. 10553 (P)
Item No. 10575 (S)

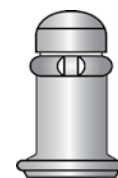

Grip Ring #88
7/16" x 7/8"
Item No. 10556 (P)

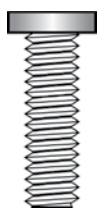

Threaded Stem #07
5/16" x 1"
Item No. 10572 (S)

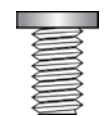

Threaded Stem #25
5/16" x 1/2"
Item No. 10554 (P)
Item No. 10573 (S)

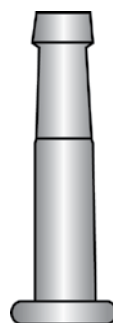

Prong #02
5/16" x 1 1/2"
Item No. 10551 (P)
Item No. 10571 (S)

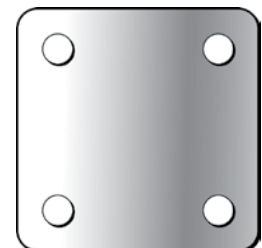

Plate #01
1 1/2" square
3/16" holes
1" x 1" hole spacing
Item No. 10570 (S)

P Fitting = Planet and Saturn
S Fitting = Nova and Satellite

CASTERS



ROYAL ROLL®

Strikingly elegant design, spherical look quiet rolling Polyflex type wheel for both carpet and tile

- fully enclosed dual bearing raceway
- stems are sturdy diecast construction
- unique brass grip ring ensures superior retention
- 2" wheel, 2 9/16" overall height
- all finished in bright nickel

EW Stem (illustrated) Item No. 10610

EH Stem type Item No. 10611

Rectangular Plate

- plate type is 2 21/32" mounted
- 2" x 1 3/16"

Item No. 10612

The Wheel Story

Generally the harder the surface, the softer the wheel should be.

Faultless offers you the choice.

Stock wheel types are, from hardest to softest.

Plaskite - for carpet

Polyflex or Nylon - either carpet or tile

Ruberex - tile

These materials have specific qualities that may be required in your customer's work area.

Casters with brake sets installed are available



STANDARD / STATESMAN - Cylindrical Casters

- the work horse
- two stock sizes
- bright nickel finish



The Standard



The Statesman

	Wheel Dia.	Pound Capacity	Installed Height	Stem Type	Wheel Type	
					Ruberex	Plaskite
The Standard	2"	80	2 5/8"	EW	10614	-
	2"	80	2 5/8"	EH	10616	-
	2 1/2"	90	3 1/32"	EW	10615	10618
	2 1/2"	90	3 1/32"	EH	10619	-
The Statesman	2"	80	2 5/8"	EH	10621	-
	2 1/2"	90	3 1/32"	EW	-	10620



Twin Wheel

- flat black 2" nylon wheel - today's popular choice
- 2 1/2" overall height, except plate type

ITW Stem (shown) Item No. 10626

Wood Stem Item No. 10627

Optional Wheel Sizes and Stems							
Style	Optional Wheel Diameter	EW	EH	ITW	Wood	EY Threaded	ES for Round or Square Tubing
Royal Roll	2"	Stock	Stock	-	Special Order	-	Special Order
Standard	1 5/8"	Stock	Stock	-	Special Order	Special Order	Special Order
Twin Wheel	1 5/8"	-	-	Stock	Stock	Special Order	Special Order
	2 1/2"	-	-	-	-	-	-

A Wide Choice of Stems

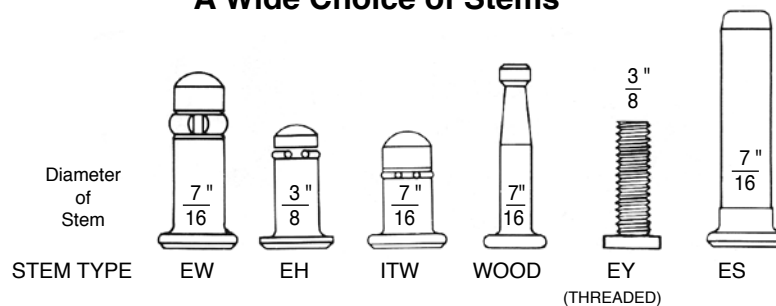

Height	EW	EH	ITW	WOOD	EY (THREADED)	ES
	1 3/8"	31/32"	1"	1 15/32"	1"	1 7/8"

PACKAGING MATERIALS



Masking Tape

- 3/4" (18 mm)
- 55 meter roll
- 12 per pack, 48 per carton

Item No. MASKTAP



Item No. CLRTAPE Item No. TANTAPE

Packaging Tape

- available in CLEAR or TAN
- 2" (48 mm) wide
- roll length: 132 meters
- sold in packs of 6 or carton of 48



F0014 Tape Gun

- dispenses our 2" packing tape
- durable metal construction
- adjustable brake

Item No. TAPEGUN

Poly Tubes

- bags and seals elongated objects
- clear poly tubing in 3 sizes
- high-slip surface makes loading easy
- use our cable ties to secure both ends (below)

15" wide 4 mil, 50 lb. roll Item No. POLY15
 24" wide 4 mil, 100 lb. roll Item No. POLY24
 44" wide 2 mil, 100 lb. roll Item No. POLY44

Kraft Paper

For Wrapping and Protecting

48" 60 lb. thickness Item No. 11930
 60" 120 lb. thickness Item No. COL216

For Pattern Making

48" 40 lb. thickness Item No. COL 114



Cable Ties

- 5 1/2" long
- heavy-duty nylon construction
- 1,000 per bag

Item No. CABLE5

SWIFTACH® Mark III Pistol Tool

- attaches inventory tags easily
- reliable, lightweight gun
- 2 stock fasteners available

Mark III Pistol Tool Item No. 11111
 Needle Kit (4 per package) Item No. 11117
 1" Fasteners - 5,000 per box Item No. 11112
 3" Fasteners - 5,000 per box Item No. 11113

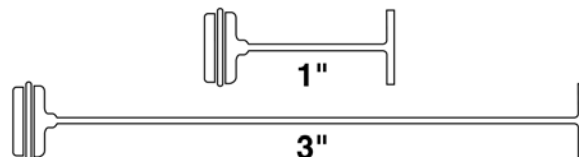

Fasteners for SWIFTACH (shown actual size) - 5,000 per box



Note: Office chair base no longer available

Visit triden.com or call 905.421.2955

HIDE-A-BED • RESIDENTIAL SOFA SLEEPER SYSTEM

Easily build an ottoman and you have an useful custom piece, any home owner would love to have.



1 Mattress Size
Length of mattress is 74" (187.9cm), 2 inches longer than normal bi-fold sleepers. Comes complete

2 Frame Construction
The Tri-Fold is a residential sleeper with a unique tri-folding system, fitting in a much-reduced space. Inside frame dimension requirement is only 27 5/8" (70cm).

3 Material Design
The sleeping surface is available in 3 different formats: polypropylene, polypropylene and wooden slats, and wooden slats only.

4 Engineered Linkage
Cross tubes in the upper sleeping area have been offset to avoid pinching points for a more enjoyable sleeping experience.



Single - Item No. 12905
Double - Item No 12909

Colorbond™ Leather and Vinyl Plastic Refinisher

Available in over 130 O.E.M. colours, restoring or changing the colour of Leather, Vinyl, Fiberglass or Metal has never been easier!

Features and Benefits

- Colorbond™ penetrates the surface of leather, vinyl, ABS, PVC, polycarbonate, acrylic, polyurethane, lexan, thermal plastic, urethane, metal, and (TPO) polypropylene, and forms a molecular bond that restores or changes the colour permanently.
- COLORBOND™ is dry to the touch in 45 seconds and bonds in 10 minutes.
- COLORBOND™ will not crack, flake or peel.
- The grain simulation is never altered or hidden, no matter how many times COLORBOND™ is applied.
- The suppleness or "hand" is never affected.
- A base and tinting system is available so an OEM colour match is achieved each and every time.
- COLORBOND™ is easy to use. In many cases COLORBOND™ is a one step process.
- COLORBOND™ is U.V. stable for use in boats too!
- COLORBOND™ can be used virtually anywhere on the car or boat. Protech is for exterior plastic car trim.
- COLORBOND™ is OEM approved and used by the Ford Motor Company.

Application Tips

- Each can of Colorbond™ Leather and Vinyl Plastic Refinisher covers approximately 8 square feet.
- follow these steps to prepare surface for Colorbond™

	STEP 1 Buff Lightly with 1,500 Wet Dry Sandpaper	STEP 2 Clean with Acetone*	STEP 3 Using Colorbond Adhesion Promoter, Apply Mist Coat Then Apply Heat at 140°F For 10 Minutes	STEP 4 Apply 3 Mist Coats of Colorbond
LEATHER		•		•
VINYL		•		•
ABS		•		•
POLYCARBONATE		•		•
PVC		•		•
LEXAN		•		•
THERMAL PLASTIC URETHANE		•		•
ACRYLIC		•		•
FIBERGLASS	•	•	•	•
TPO	•	•	•	•
METAL	•	•	•	•

*Acetone - 4 Litre tin Item No. 12075

OEM Colours Available from Colorbond™

Sea Ray #3 Off White/Egg Shell	Item No. 17000	Honda #241 Mist	Item No. 17044	GM #522 Ebony	Item No. 17088
GM #64 Crimson	Item No. 17001	Honda #243 Dk. Graphite	Item No. 17045	GM #523 Dk. Cashmere	Item No. 17089
GM #65 Garnet	Item No. 17002	Honda #244 Black	Item No. 17046	GM #524 Gloss Ebony	Item No. 17090
Ford #66 Light Mocha	Item No. 17003	BMW #252 Gray-'88 up-7 Series	Item No. 17047	GM #525 Lt. Neutral	Item No. 17091
Ford #69 Lapis	Item No. 17004	BMW #253 Ghost Gray- All	Item No. 17048	GM #526 Lt. Titanium	Item No. 17092
Ford #75 Crystal Blue	Item No. 17005	BMW #254 Nat Tan - 84-86 - 3 Series	Item No. 17049	#103 Navy	Item No. 17093
GM #98 'Vette Red	Item No. 17006	BMW #255 Tan- 88-91-5 Series	Item No. 17050	#134 Chrome Yellow	Item No. 17094
Sea Ray #105 White	Item No. 17007	BMW #256 Tan-'93 up	Item No. 17051	#135 Competition Red	Item No. 17095
Sea Ray #107 Light Gray	Item No. 17008	BMW #257 Burgundy	Item No. 17052	#136 Bombastic Blue	Item No. 17096
Ford #115 M. Prairie Tan	Item No. 17009	BMW #258 Black	Item No. 17053	#137 Envy Green	Item No. 17097
Ford #116 Dark Graphite	Item No. 17010	BMW #259 Charcoal	Item No. 17054	#144 Skid Mark Black	Item No. 17098
Ford #117 Light Graphite	Item No. 17011	Ford #324 Charcoal Black	Item No. 17055	#268 Purple Haze	Item No. 17099
Ford #118 Med. Graphite	Item No. 17012	Ford #325 Med Dove	Item No. 17056	#269 Midas Gold	Item No. 18000
Ford #119 Black	Item No. 17013	Ford #326 Camel	Item No. 17057	#270 Cosmic Platinum	Item No. 18001
Ford #120 M. Dk. Parchment	Item No. 17014	Ford #327 Midnight Black	Item No. 17058	Searay #106 Black	Item No. 18002
Ford #121 M. Parchment	Item No. 17015	Ford #328 Dark Flint	Item No. 17059	#20 Clear Finish	Item No. 18003
Ford #148 M. Dk. Graphite	Item No. 17016	Ford #329 Light Flint	Item No. 17060	#294 Clear Satin Finish	Item No. 18004
Ford #150 Lt. Prairie Tan	Item No. 17017	Ford #330 Med Dk Flint	Item No. 17061	#295 Clear Low Gloss Finish	Item No. 18005
GM #153 M. Dark Neutral	Item No. 17018	Ford #331 Med Flint	Item No. 17062	#213 Leather Conditioning Sponge	Item No. 18006
GM #154 M. Dark Pewter	Item No. 17019	Ford #332 Espresso	Item No. 17063	#214 Vinyl/Plastic Conditioning Sponge	Item No. 18007
GM #155 M. Dark Oak II	Item No. 17020	Ford #333 M. Light Stone	Item No. 17064	#215 Adhesion Promotor	Item No. 18008
GM #156 Shale	Item No. 17021	Ford #334 Granite	Item No. 17065	Ford #536 Med. Satin Nickle	Item No. 18013
GM #157 M. Dark Pewter II	Item No. 17022	Ford #335 Shale	Item No. 17066	Ford #617 Dark Dove Gray	Item No. 18014
GM #158 M. Neutral II	Item No. 17023	Ford #336 Dove Gray	Item No. 17067	GM #643 Lt. Cashmere	Item No. 18015
GM #159 Very Dark Pewter	Item No. 17024	Ford #337 Light Parchment	Item No. 17068	GM #644 Dark Khaki	Item No. 18016
Chrysler #160 Dark Slate	Item No. 17025	Ford #338 Black Ink	Item No. 17069	GM #645 Lt. Khaki	Item No. 18017
Chrysler #162 Taupe	Item No. 17026	Ford #339 Dark Stone	Item No. 17070	GM #646 Dark Slate	Item No. 18018
Chrysler #163 Agate	Item No. 17027	Ford #340 Medium Pebble	Item No. 17071	GM #647 Lt. Slate	Item No. 18019
Chrysler #164 Lt. Mist Gray	Item No. 17028	Ford #341 M. Dk. Pebble	Item No. 17072	Ford #648 King Ranch	Item No. 18020
Chrysler #165 M. Mist Gray	Item No. 17029	Ford #342 Dk. Pebble	Item No. 17073	Chrysler #649 Beige	Item No. 18021
Chrysler #166 Dk. Mist Gray	Item No. 17030	Ford #343 Lt. Pebble	Item No. 17074	GM #650 Med. Neutral Tan	Item No. 18022
Nissan #192 Gray	Item No. 17031	Ford #344 M. Light Pebble	Item No. 17075	GM #651 Graphite	Item No. 18023
Nissan #193 Beige	Item No. 17032	Ford #345 M. Light Flint	Item No. 17076	GM #652 Dk. Pewter	Item No. 18024
Nissan #194 Rouge	Item No. 17033	Ford #346 Cashmere	Item No. 17077	Ford #653 Med. Stone	Item No. 18025
Nissan #197 Graphite	Item No. 17034	Mercedes #348 Orion Gray	Item No. 17078	Ford #654 Dusk Gray	Item No. 18026
Toyota #231 Ivory	Item No. 17035	Mercedes #349 Anthracite	Item No. 17079	Ford #655 Med. Dk. Camel	Item No. 18027
Toyota #232 Sahara	Item No. 17036	Mercedes #350 Java	Item No. 17080	BMW #656 Tabac 2007	Item No. 18028
Toyota #233 Desert	Item No. 17037	Mercedes #351 Borneo	Item No. 17081	BMW #657 Beige 2007	Item No. 18029
Toyota #234 Titanium	Item No. 17038	Ford #516 M. Camel	Item No. 17082	BMW #692 Med. Gray 2007	Item No. 18030
Toyota #235 Nickel	Item No. 17039	Ford #517 Lt. Camel	Item No. 17083	Protech #622 Black	Item No. 18031
Toyota #236 Mist	Item No. 17040	Ford #518 Sand	Item No. 17084	Protech #623 Gloss Black	Item No. 18032
Honda #238 Buckskin	Item No. 17041	Ford #519 M. Dk. Sand	Item No. 17085	Protech #624 Charcoal Metal	Item No. 18033
Honda #239 Sahara	Item No. 17042	Ford #520 Lt. Stone	Item No. 17086	Protech #625 Gloss Silver	Item No. 18034
Honda #240 Nickel	Item No. 17043	Ford #521 Greystone	Item No. 17087	Protech #626 White	Item No. 18035
				Protech #627 Titanium Metal	Item No. 18036

GLIDES & LEGS

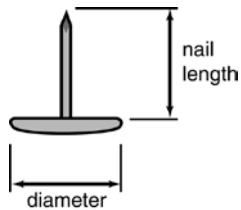

GLIDES

- all styles sold in 100's or 1,000's
- nail length dimension given is measured from flange of nail to tip
- as shown in diagram diameter is overall width of base

Carpet Glides



- nail type
- has carpet base
- ideal for wood floors
- 1/2" nail

3/4" diameter Item No. 11813



Glide 3 Prong

- steel 5/8" diameter
- 4000 / ctn

Item No. 11806

Item No. 11804 - 1/2" dia

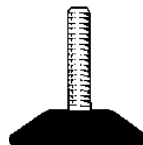

Leveller Glide

- 1 1/2" x 5/16" threaded bolt
- 1 11/16" diameter black
- plastic base

Item No. 11826



Rubber Set Glide

- black rubber cushions
- nickel finish metal base
- slides well on hard or carpeted surfaces
- 3/4" nail

7/8" diameter Item No. 11814



Non-Slip Rubber Glide

- black rubber
- 3/4" nail

15/16" diameter ItemNo.COL123

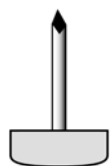

Nylon Glides with Nail

- 1/2" diameter, 5/8" nail
- great as a wall protector
- rounded dome head, tan

Item No. 11817

- 5/8" diameter, 5/8" nail
- flat head, beige

Item No. 11818

- 3/4" diameter, 11/16" nail
- flat head, white

Item No. 11819

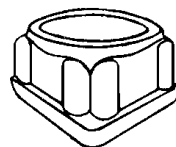

XL 240

- black plastic
- fits square metal tubing
- for use with stacking type chairs

Fits 3/4" tubing Item No. 11822

Fits 7/8" tubing Item No. 11828

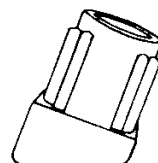

XL 250

- same as above but in a 45° angle

Fits 3/4" tubing Item No. 11824

Fits 7/8" tubing Item No. 11827



No-Mar Glides

Teflon® base slides on ceramic floors

- 7/8" diameter base - 5/8" nail

Item No. 11799

- 1 1/8" diameter base - 5/8" nail

Item No. 11797

- 1 1/2" diameter base - 9/16" nail

Item No. 11798



3/4" Nylon Glide

- dark brown

Item No. 11807



Round Glide

- black plastic
- fits 1 1/2" outside diameter tubing

Item No. 11808

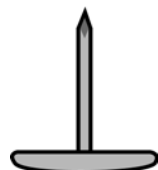

Polished Steel Glide

- heavy duty nail
- nickel colour

#2 - 3/4" diameter base - 3/4" nail

Item No. 11800

#3 - 5/8" diameter base - 5/8" nail

Item No. 11802

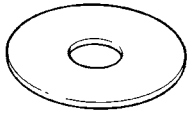

Plastic Leg Hole Finders

- acts as a guide for t-nut opening under lining to ease leg installation
- 1 5/8" diameter
- bright white
- Sold in 1,000's

Item No. 12124



Plastic Legs

- 2" dia. x 1 3/4" high
- all plastic

Black Item No. 11796

T-Nuts

- dimension quoted is diameter of threaded hole
- packaged in 100's



Prong Type



Plain Type

Type	Length	Item No.
Prong	1/4"	13196
Prong	5/16"	13198
Plain	1/2"	13199
Plain	5/16"	13197
Metric	8 mm	13195



Hanger Bolts

5/16" x 3 1/2"

Item No. 11870*

1/2" x 3 1/2"

Item No. 11871

* Standard Hanger Bolt for our legs



Dowel Screw

5/16" x 3 1/2" Item No. 11872

Finished Walnut Legs

- complete with hanger bolt and steel glide



Tapered

Type	Length	Description	Item No.
Straight	2"	Straight	12100
Straight	2 1/2"	Straight	12104
Straight	3"	Straight	12108
Tapered	4 1/2"	Tapers 1 1/2" to 1 1/8"	12113
Tapered	5"	Tapers 1 3/8" to 3/4"	12116
Tapered	6"	Tapers 1 1/2" to 1 1/4"	12115
Tapered	6"	Tapers 1 1/2" to 7/8"	12118

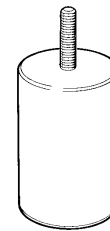

Straight

DECORATIVE FINISHED FURNITURE LEGS



Square Tapered Leg

- complete with hanger bolt
- dark walnut finish
- 4" high, 4 1/2" wide, tapers to 3 1/2"

Item No. 12105

Queen Ann Leg - Discontinued



Finished Bun Legs

- comes with hanger bolt
- has 2 holes for screws
- 2 5/8" high x 5 1/2" dia.

Cherry Finish Item No. 12131



Finished Block Legs

- complete with hanger bolt & plastic glide
- 2 1/2" high, 2 1/2" at top, tapers to 2 1/2" at bottom

Espresso Finish Item No. 12092

FOAM & FILLERS

Triden is your leading expert on foam used in all types of upholstery - domestic and contract.

We can assist you in areas that require exacting specifications and will use our years of experience to recommend the correct foam.

To order foam, choose the type or density required, then the compression you desire and then finally the overall dimensions. All foam is stocked in standard sheet dimensions and we also provide a wide variety of roll stock. Special sizes can also be ordered - call for details.

OUR BEST ! Qualux HR (Hi-Resiliency) POLYMERIC URETHANE FOAM

A significant advancement in the manufacture of polyurethane foam has resulted in Qualux - offering superior comfort while not compromising quality. This HR type foam maintains its firmness under stress. Qualux is longer lasting and makes a rich lush seat or mattress for high quality furniture. A density of 2.5 lbs. ensures excellent seating with Qualux - every time.

Qualux is also available in mattress sizes and special cuts and thicknesses.

Just call for details.

QUALUX Stock Sheet Sizes		Thickness				
Compression	Width	5"	4"	3"	2"	1"
Q-41 Firm	22"	11199	11200	11202	11204	11206
Q-31 Medium Firm	22"	11207	11210	11212	11214	-
Q-26 Medium	22"	11220	11224	11226	11228	11230
Q-16 Soft	22"	11239	-	11244	11246	-
Stock Sheet Length: 88"						
Non-stock sizes are available - Ask us about special orders.						

“DURALUX” High Resiliency Foam

- 2.5 pound density

DURALUX Stock Sheet Sizes		Thickness				
Compression	Width	5"	4"	3"	2"	1"
DX 85 Extra Firm	22"	-	11569	11568	11567	11566
DX 45 Firm	22"	11510	11511	11512	11513	11514
DX 35 Medium	22"	11516	11517	11518	11519	11520
DX 24 Soft	26"	11504	11505	11506	11507	-
Stock Sheet Length: 88"						
Non-stock sizes are available - Ask us about special orders.						

CURON - High Density Polyurethane Foam

Solid quality, solid value. Curon foam is today's choice for many different applications. Curon is a good economical High Density (2.2 lb.) foam for use in all manner of furniture and related applications.

Curon is also available in special order sizes. Please call us with dimensions required. Put the Foam Experts to work. Curon is also manufactured to meet MVSS 302 fire retardancy standards.

Stock sheet size is 22" x 88"

Custom sizes are available - Please Inquire at our Order Desk.

Thickness	C 24 Soft	C 45 Firm	C 35 Medium	C 85 Extra Firm
6"	-	-	11279	-
5"	11296	11266	11280	-
4"	11298	11270	11284	11261
3"	11300	11272	11290	11262
2"	11302	11274	11292	11263
1"	-	11276	11294	11264

ILD - INDENT LOAD DEFLECTION

DENSITY AND COMPRESSION - HOW WE MEASURE FOAM

Foam is measured using industry wide testing procedures in order to predetermine its qualities.

Density is calculated at the time of formulation. Qualux is 2.5 lbs. of density, Curon is 2.2 lbs. of material per cubic foot, while regular white poly foam ranges from 1.0 lbs. to 1.5 lbs. of density.

Compression is the measure of how much pressure it takes to push the foam down a specific amount. Specifically a round disk, as illustrated, with a surface area of 50 square inches is pushed down on a 4" sheet of foam.

The amount of pressure, measured in pounds, required to "compress" the foam down by 25% of itself - specifically the pounds of pressure required to push a 4" thick piece of foam to 3", is the measure of the foam's compression.

There is a range of allowable tolerance, usually +/- 5 pounds, but the number following the foam type, eg. Q41 indicates 41 pounds of compression - a very firm piece of foam.

When selecting foam first decide on the density (Qualux, Curon, etc.) and then the compression required (firm, medium or soft). There are many different types of foam. We have listed selected stock items only.

Show us a sample - we will endeavour to supply it!

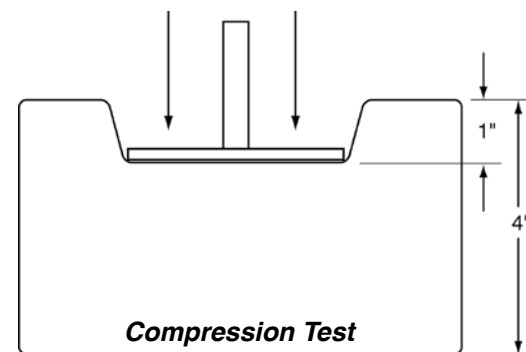

FOAM & FILLERS

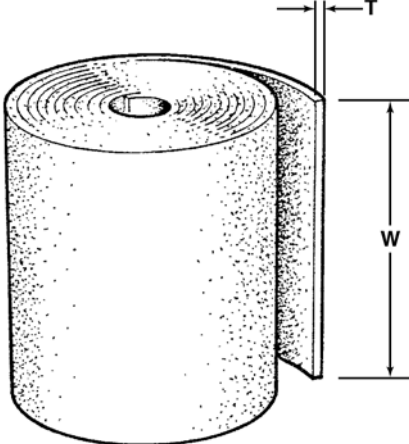

Foam Rolls L39 (1.25lb. density)

- convenient roll sizes

Width	Thickness			
	1/4"	1/2"	3/4"	1"
24"	11390	11396	11410	11418
30"	11392	11398	11412	11420
54"	11391	11400	11414	11422
Overall Length	66 yds.	33 yds.	16 yds.	16 yds.

L39 Foam

- 1.25 lb. density, 39 lbs. compression

Thickness	24" x 88"	56" x 74"
5"	11320	11330
4"	11322	11332
3"	11324	11334
2"	11326	11336
1"	11328	-

We can shape foam to suit your application. Just ask us!

R17 Poly - Soft

Dimension	Item No.
5" x 22" x 88"	11359
4" x 22" x 88"	11360
3" x 22" x 88"	11362

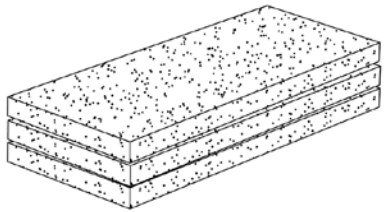

*See our **Cushion Wrap** on page 33 and **Foam Cements** on page 4*

R12 Poly - Super Soft

Dimension	Item No.
4" x 22" x 88"	11370
3" x 22" x 88"	11372
2" x 22" x 88"	11374
1" x 22" x 88"	11376

SAVE AND ORDER BY THE BUNDLE

REBOND (Bonded Chip Foam)

A 4 lb. density sturdy replacement foam. Recommended in all types of transportation seating. Sheets are 22" by 72" long. Order in bundles to save.

Also available in 6 pound density - Call for details

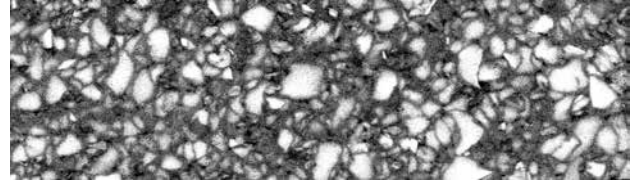

1" Item No. 11496 3" Item No. 11492
2" Item No. 11494 4" Item No. 11490

Our Stock Wedge L-39

To order Shaped Bolsters, in suitable quantities, quote dimensions as we describe them here.

Choose from any density foam.

A	Top	Actual 4"
B	Bottom	8"
C	Height	12"
D	Length	36"

Item No. 11472

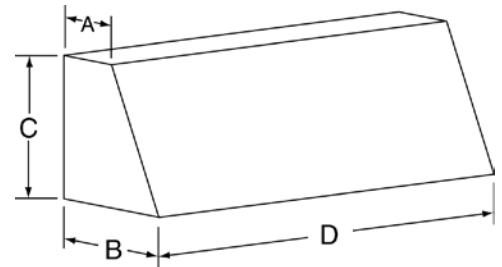

Shredded Poly

- ideal for stuffing throw cushions and loose pillow backs
- 20 lb. returnable bags
- regular grade poly

Item No. 11480

Poly Foam Half Moons

- 4" X 40"

Item No. 11443

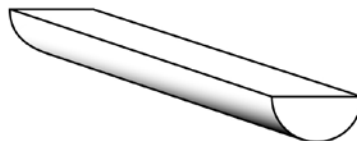

Round Bolsters

- 22" Poly Cylinders

Item No. 11474

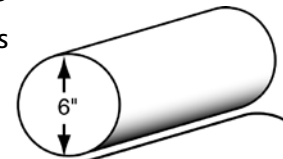

Item No. 11476

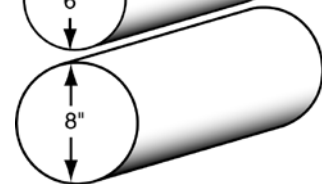

THROW CUSHIONS

Dacron® 91	
Dimensions (Prior to filling)	Item No.
14"	10780
16"	10784
18"	10788
20"	10792
22"	10793

20% Down 80% Feather	
Dimensions (Prior to filling)	Item No.
16"	10782
18"	10786
20"	10790

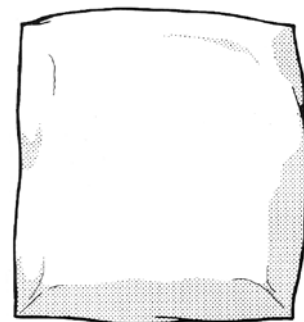

Size not listed ?Have us quote shape / size

Covered in white Accord® excellent accent piece when covered with your fabric.

FOAM & FILLERS

DOWN AND FEATHERS

THE ULTIMATE IN QUALITY. PAMPER YOUR CUSTOMER.

**See our
downproof ticking
on page 34**

Percentage Blend Down to Feather	Item No.	
	10 lb.	25 lb.
75 - 25	11141	11142
60 - 40	11139	11140
50 - 50	11137	11138
40 - 60	11135	11136
20 - 80	11133	11134

Order by the 25lb. bag or the convenient 10 lb. bag size.

Our down mixtures are Sanitized for your protection.

We also custom make Throw Cushions

POPULAR FILLER MATERIAL - UPHOLSTERY GRADE FELT

Grade "A" Felt

- approximately 75' long, 27" wide
- interleaved with paper - insures consistency, won't fall apart
- order by the 30 pound bale

Item No. 11115

Shredded Poly

- ideal for stuffing throw cushions and loose pillow backs
- 20 lb. returnable bags
- regular grade poly

Item No. 11480

Chevron Hair

- for double stuffing
- 85 % hog hair
- 15 % chevron
- 50 lb. bag

Item No. 11126

COMFOR - FIBRE

- synthetic clusters imitate feather & down with no allergenic side effects
- cluster shape is retained by unique engineering - will not flatten out prematurely
- use down-proof ticking to create a crisp yet comfortable finished product
- a real premium synthetic solution for contract and custom seating

Ask for a sample today!

15 lb.bag Item No. 11175

A leading Toronto area designer, Lois Macauley would like to share a great tip! If you combine 50% Comforel and 50% natural feather/down combination, the mixture stands up better in the cushion. More comfort for your customer, longer lasting support for the cushion. It is important to knead the two fillers together, inside the casing, and then enjoy the results.

SYNTHETIC FIBRE FILLERS

- Polyester Fibre is**
- Odourless
 - Non Allergenic

- Use Fibre**
- Cushion wrap
 - Back cushions
 - Throw cushions and pillows
 - Outdoor furniture filler

- Fibreloft**
- Low melt fibres bonded with heat
 - No resin - eliminates ridging
 - Flame Retardant



Description	Width	Approx. Wt.(lb.) per Roll	Approx. Roll Length	Non-Vac	Vac-Packed
Fibreloft (Low Melt)	27"	12.5	80'	11148	-
	30"	12.5	75'	11149	-
	54"	25	40'	11147	-
7/8oz Bonded Fortrel with resin* (splittable)	27"	10	80'	*	*
	30"	12.5	75'	*	-
	63"	25	35'	*	-
1/2 oz Bonded Fortrel with resin*	27"	9	120'	*	*
	63"	18	120'	*	*
C-15 Loose • economy fibre • stuff throw cushions or toys	30"	20	n/a	11178	-

** A fire in July 2014 has upset production. Details to follow*

THS Blown Fibre

- loose polyester slickened fibre for cushion stuffing
- easy to work with
- excellent quality

24 pound bale Item No. 11180

Kapok

Pure plant fibre from Kapok trees, high self-purification ability, anti-bacterial due to natural bitterness, grown in the wild.

5 pound bag Item No. 11120

Styrofoam Beads

- contains no CFCs for bean bag chairs
- 12 cubic feet (36" x 24" x 24")
- 11 pounds (approx.)



Item No. 11128

Hollow Lowmelt

- 3" thick, 30" width
- 14.5 oz.
- 30 pounds / roll

Item No. 11183

**May we suggest 37" or 56"
Downproof Ticking for your casing?
See page 34 for details.**

LININGS & DECKING

Type	Colour	Width	Approx. Roll Length	Item No.
Decking - Cotton Twill (6 oz.)	Black	60"	50 yards	12213
Futon Heavy Duty Lining (Extra Heavy - 5 oz./sq.yd.)	White	59"	109 yards	12140
Lining - # 1113 Cotton (4.5 oz. - Heavy Weight)	White	38"	100 yards	12142
Lining - # 1010 Cotton (4 oz. - Medium Weight)	White	48"	100 yards	12143
Lining - Bleached (4 oz Poly / Cotton)	White	60"	100 yards	12146
Lining - Poly / Cotton (4 oz.)	Black	60"	218 yards	12212
Lining - Poly / Cotton F/R (4 oz.)	Black	60"	100 yards	12214
Lining - # 1155 (65% Poly - 35% Cotton)	Natural	69"	50 yards	COL 838
Ticking, ACB mattress F (100% Cotton)	Gray and White Striped	84"	50 yards	12196
Ticking, Downproof (For feather and down cushion casings)	Natural	37"	100 yards	12192
	Natural	56"	100 yards	12193
Display Felt Great for Desk drawer lining	Billard Green	72"	50 yards	19880

Ask for a Sample Set

***We also stock a wide variety of Deck Lining
in assorted colours and widths.
Call our Order Desk for details
on our latest offerings.***

SYNTHETIC LININGS

KEVLAR® Fireblocker Fabric

- spunlaced 100% Kevlar® aramid fibre by Dupont®
- self-extinguishing and inherently flame resistant
- easily laminated onto full rolls of fabric
- use to pass California 133 FR test
- also available as bottom lining

Width	Weight	Item No.
56"	2 oz	19890
FRQ Quilted		
60"	6.4 oz	19885

Propex FLW

- needle punched
- fluffy backed, woven synthetic
- neutral colour

Width	Description	Item No.
30"	100 & 250 yard rolls	12150
36"	100 & 250 yard rolls	12152
above styles also available in cut lengths		
7" wide for pulls	250 yards only	12153

Tygar Lining

- excellent value bottom black lining
- nonwoven, synthetic - the industry standard

Width	Item No.
30"	12166
36"	12168
72"	12164
100 yard or 250 yard rolls or cut lengths	

Cyrex Synthetic Cheese Cloth

- fits over foam and fibre
- eliminates drag for easy slipping or filling
- .03 ounce x 36"

Item No. 12172

Rodon Deck Lining

- 100% Bonded Polypropylene
- 3.7 ounces per square yard
- embossed pattern
- use with leather cushions
- 30" width - 100 meters / roll

Black Item No. 12148

Beige Item No. 12147

Hospital Vinyl Ticking

- 14 ounces per square yard
- 39" width

Light beige Item No. 12199



Black Accord		
Width	Width	Item No.
1.25 ounce	24"	12156
1.25 ounce	30"	12157
1.25 ounce	36"	12161
1.25 ounce	38"	12169
1.5 ounce	42"	12158
2 ounce - Heavy	36"	12160
100 yard or 273 yard rolls or cut lengths		

ACCORD® Bottom Lining

- designed expressly for the furniture trade
- 100% polypropylene olefin
- nonwoven spunbound high quality
- bottom cloth and throw cushion cover

White Accord		
Width	Width	Item No.
1.25 ounce	24"	12159
1.25 ounce	36"	12163
1.25 ounce	48"	12162
2 ounce - Heavy	38"	12149
100 yard or 273 yard rolls or cut lengths		

LININGS & DECKING

Pellon Skirt Lining

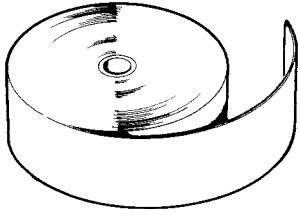

- valance stiffener of choice
- 2 grades available
- we also supply roll widths so you can cut to suit
- pre-slit in convenient widths, (sold by the roll only)

508 Extra Firm	Length	Item No.
5 1/2"	65 yard roll	12457
7"	65 yard roll	12458
Full Roll Order cut lengths or full rolls	40"w x 65 yard roll	12459

Fusible Pellon

250 Yard Roll

10" Item No. 12452

60" Item No. 12450

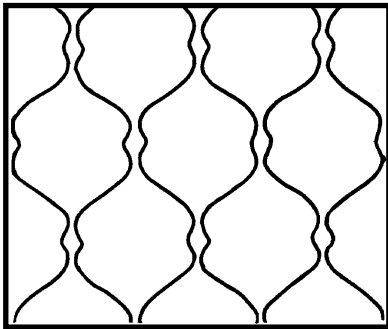

Quilted Decking - The Classic

- beige
- quilted 30" material
- 54 yard rolls or cut yardage

Foam filled Item No. 12185

Polyester Decking

- white decking material
- 24" or 30" wide
- 24" available in 30 foot or 150 foot rolls

24" width - Item No. 11916 - 150 feet

30" width - Item No. 11918 - 150 feet

Deck ECONO Padding - Grey

- 75 foot roll
- 30" width

Item No. 11911

NPF Padding - White

- white polyester
- needle punched
- very soft
- 1/8" thick - 61" width

Item No. 11913

Comfor-Dry™ Mattress Ticking

- 3 to choose from
- permanent fluid barrier
- non-allergenic, non-irritating
- combats bacterial and fungal growth
- supple hand offers exceptional comfort
- flame retardant - All pass CAL 117 Section E 2013

Green Vinyl Ticking

- 78" wide - 10 oz. / sq. yd.
- anti-static, foam compatible

Item No. 12195

Black Conductive Vinyl Ticking

- 60" wide - 10 oz. / sq. yd.
- conductive surface controls electrostatic discharge

Item No. 15535

Urethane Knit 4-Way Stretch Navy Vinyl Ticking

- 43" wide - 7 oz. / sq. yd.
- anti-static, foam compatible

Item No. 35001

Ask for our Sample Card

INSULATORS



Needle Punch Recycled Fibres

- heavy weight
- 1/4" thick

24", 100 yard roll - Item No. 11909

30", 100 yard roll - Item No. 11910

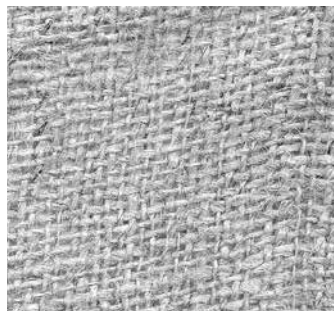

Hessian

- also known as burlap
- 10 ounce weight
- 40" wide
- 100 yard bolts or cut lengths

Item No. 11874

Heavy Weight Deck Pad

- white polyester
- 1/4" thick

24" x 100' - Item No. 11909

30" x 100' - Item No. 11910

HAND TOOLS



Bronze Magnetic Solid Head Hammer

- head is 5 1/2" long
- weighs 7 ounces
- No. 33

Item No. 13800



Upholstery Stripping Tool

- attaches to a standard drill
- faster, easier way to strip furniture
- go to www.triden.com to see a demo video

Item No. 13810



Bantam Stripping Tool

- includes chisel

Item No. 14091



Split Type Magnetic Hammer

- head is 5 1/2" long
- weighs 7 1/2 ounces
- No. 222

Item No. 13804



Ripping Tool

- plain chisel edge, plastic handle
- No. 402

Item No. 13840



Claw Tool

- combined ripping and tack puller
- No. 402 1/2

Item No. 13842

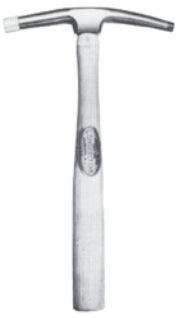

Nylon Tip Hammer

- to use on ornamental nails
- same specifications as No. 33
- No. 36

Item No. 13802

Replacement Tip

Item No. 13803



Berry Staple Remover

- made of 4140 alloy tempered steel
- unchanged since 1966
- No. 124

Item No. 13866



Staple Remover

- No. 121

Item No. 13864



Stripping Hammer

- double edged blade for stripping off old fabrics
- 5" head - weighs 1 lb.
- No. 277

Item No. 13808

Replacement Handle

Item No. 13806



Ripper Claw Tool

- angled cup style prongs provide extra leverage
- No. 200

Item No. 13843



Staple Remover

- No. 120

Item No. 13860



Staple Lifter

- angled for prying
- No. 120 1/2

Item No. 13862



Fancy Nail Spacer

- set up to 5 nails head to head
- No. 777

Item No. 13814



Webbing Stretcher

- 7 1/2" long
- 3 3/8" wide
- No. 255

Item No. 13816



Gooseneck Webbing Stretcher

- No. 253

Item No. 13818



Tucking Tool

- No. 747

Item No. 13813

WISS® “Inlaid” Shears

SHEARS

These are the finest quality Wiss® shears you can buy. They are manufactured by a special Wiss® process resulting in shears that have a longer lasting cutting edge and are superior to ordinary shears of one piece construction.

NOTE: Dimensions shown are overall length.



Heavy Duty Shears with Cushion Grip

- red cushion grip handle for maximum comfort
- No. W20P
- 10" (4 3/4" blade)

Item No. 14027



Knife Edge Upholstery Shears

No. 1225 10" Item No. 14032

No. 1226 12" Item No. 14034



Wide Blade Upholstery Shears

No. 20W - 10" - Item No. 14026

No. 22W - 12" - Item No. 14030



Heavy Duty Industrial Shears

No.	Length	Type	Item No.
20	11"	Bent Trimmers	14022
20L	10"	Left Handed Trimmers	14024
22	12"	Bent Trimmers	14028



Quick Clip Thread Clippers

No. 1570

Item No. 14038

Replacement Blades

Item No. 14040



Mundial Industrial Shears

- featuring "stay set pivot" blades
- manufactured from special cutlery steel
- nickel plated forged blades

420 - 10" Item No. 14019

422 - 12" Item No. 14017



Leather Shears

- featuring one serrated blade for gripping leather
- No. 2DA
- 8 1/4" (2 1/4" blade)

Item No. 14035



Dressmaker Shears

No. 29 9" Item No. 14020

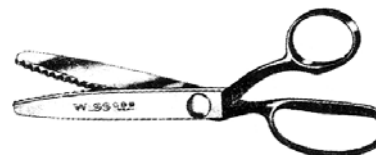

Pinking Shears

No. AA - 10 1/2" - Item No. 14044

No. CB - 9" (shown) - Item No. 14045

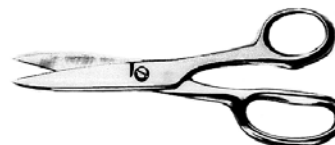

No. IDS Short

8" - 3" blade - Item No. 14036

HAND TOOLS



Webbing Stretcher Pliers

No. 250 3 1/2" wide jaw
Item No. 13824

No. 251 1 3/8" jaw
Item No. 13822



3 Prong Spring Clip Pliers

• No. 445

Item No. 13832



BW Clip Pliers

• No. 522

Item No. 13833



Zipper Stop Pliers

- crimps any sized zipper stop easily
- complete with opening spring, soft vinyl handles
- No. 1012

Item No. 13823



Metal Webbing Stretcher

- 4 in one tool for stretching No-Sag, metal webbing, punched straps, etc.
- flat handle gives lots of leverage
- No. 258

Item No. 13819



Lever Stretcher

- for stretching No-Sag on frames
- No. 268

Item No. 13820



Duck Bill Pliers

- stretches material in tight places where space is limited
- No. 98

Item No. 13823



Hog Ring Pliers - Angled

- with spring
- 135° angle w/opening spring 13830
- Closing replacement spring 13831
- Opening replacement spring 13829

No. 1440 B

(opening spring type)

Hog Ring Pliers

- no spring
- Straight Item No. 13826
- Angled Item No. 13827



Hog Rings

Loose or paper strip for air tools

- No. 1012

Automatic Hog Ringer - See Page 51



Revolving Canvas / Leather Punch

- rotating head punches 6 hole sizes from 5/64" to 3/16"

Item No. 13925



Revolving Leather Punch

- heavy duty industrial grade tool

Item No. 13924

No. 155

Cutting Tubes for No. 155

- high carbon tooled steel
- threaded for easy replacement

Tube No.	1	2	3	4	5	6
Diameter	3/32"	7/64"	1/8"	5/32"	11/64"	3/16"
	●	●	●	●	●	●
Item No.	13900	13901	13902	13903	13904	13905

Replacement Anvil # 155A - Item No. 13906



401-2 Spring Bender

- 2 per set

Item No. 12795



No. 267 Seam Stretcher

- adjustable from 12" to 36"
- holds casing evenly for hand sewing

Item No. 13914



Trimming Knife

- rosewood handle
- No. 76 1/2

Item No. 13876



Auto Trimmer's Knife

- No. 1020

Item No. 13878



Trim Knife

Item No. 13880



Replacement Snap Off Blades

Item No. 13882 - 10 blades/pack

Item No. 13884 - 50 blades/pack

Tufting Clasps

Sold in 100's or 500 to a box



No. 418 Item No. 13852

Tufting Needle

Time saving tool for replacing buttons

No. 417 Item No. 13850



Pull Thru Needle

- 11" long
- No. 615

Item No. 14181



Hollow Tufting Needle

- for easier inserting of prong buttons through fabric and fillers.
- No. 419

Item No. 13856



Hickory Wooden Mallet

No. 4 (89.5) - 1 3/4" face

Item No. 13894

No. 3 1/2 - 2" face

Item No. 13896



Rawhide Mallet

• 2" face. head made of rolled rawhide

• No. 196-4

Item No. 13898



Leather Face Mallet

• maple handle, ash head

• no-mar side covered in leather

Item No. 13895



Foam Cutter Bit

• 1" dia.drill bit to cut holes for tufting

• No. 1212

Item No. 13890

As above for 3/4" holes

Item No. 13892



Arch Punch

• for cutting holes 7/8" dia. in foam or other substrates

• No. 149

Item No. 13922

Item No. 13919

1/2" hole cutter



Piping Tins

• for fluting or channelling

• No. 412

2" Item No. 13918

3" Item No. 13917

4" Item No. 13916

Other sizes are available by special order



Automatic Awl

• for hand sewing leather and canvas

• No. 413

Item No. 13926

Replacement reels of black thread

Item No. 13928

Replacement Needle

Item No. 13927

Wooden Ruler

• 60", 1 3/4" wide

Item No. 13908

Item No. 13907 - 36"

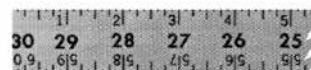

Aluminium Rule - Inches & Metric

• 60", 1 1/2" wide

• anodized aluminium

• No. 161

Item No. 13910 - 60"

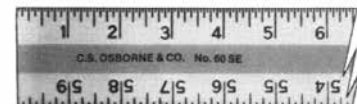

Aluminium Straight Edge Rule

• 60" 2" wide.

• heavy 1/8" thick

• No. 60 - SE

Item No. 13912

HAND TOOLS



Klinch-It Tool

permanently fastens coil springs to web base with sturdy steel clips

Item No. 13940

Replacement Bottom Plates

Item No. 13941

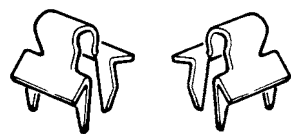
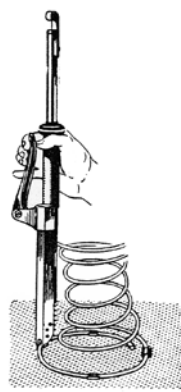

Klinch-It Fasteners

Shipped 5,000 to a box on magazine sized paper strips.

Item No. 11920

"Bazooka" Air Blower



- for cushion filling or quick clean ups
- 2" dia. x 28" long
- fits standard 1/4" air line

Item No. 13913

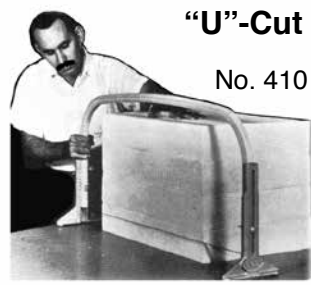

"U"-Cut Foam Slicer

No. 410

cuts slabs horizontally from 1/4" to 9" thickness, and up to 36" in width

Item No. 13970

Replacement Blades Available

Osborne Spring End Former

crimps the ends of coil and No-Sag springs

Item No. 12796

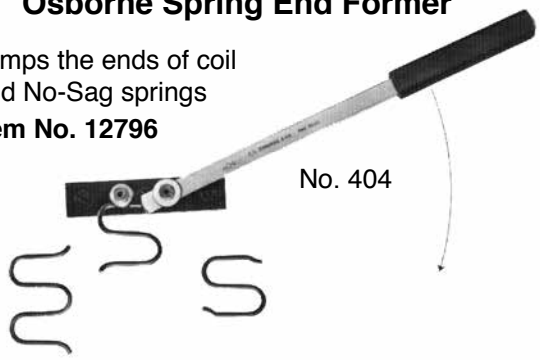

No. 404

Osborne Edge Wire Former

quickly bend No-Sag springs or edge wire into complex shapes

- can be mounted to a vise easily
- made with heat-hardened steel

Item No. 12798

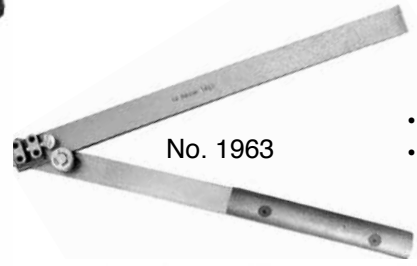

No. 1963

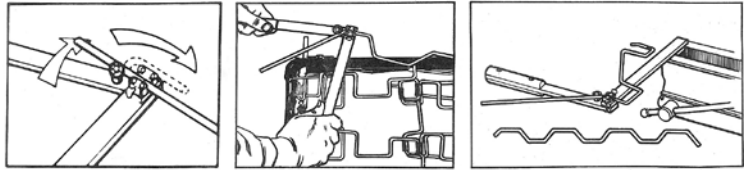

Osborne Needle Kits

K-3 Curved Round Point Needle Kit

Needle Kit

Each K-3 Kit Contains 1 each of the following needles:

- 3" x 18 ga.
- 4" x 17 ga.
- 5" x 16 ga.
- 6" x 15 ga.

Item No. 12390

This kit is also available in Bayonet Point Needles

K-4 Kit

Item No. 12391



K-7 Curved Round Point Needle Kit - Light Gauge

Needle Kit - Light Gauge

Each K-7 Kit Contains 1 each of the following needles:

- 2 1/2" x 20 ga.
- 3" x 19 ga.
- 3 1/2" x 18 ga.
- 4" x 18 ga.

Item No. 12392



Curved Needles

Overall length is measured from eye to point.
Chart shows distance across curve.



Square "Bayonet" Style Point

Overall	2"	2 1/2"	3"	4"	5"	6"	7"	8"
Across	1 1/2"	1 3/4"	2"	2 3/4"	3 3/8"	4"	4 3/4"	5 1/4"



Round Point

Curved Bayonet (Square) Point - 502 1/2 Light								
Overall Length	2 1/2"	3"	3"	4"	5"	6"	7"	8"
Gauge	18	18	16	17	16	15	15	15
Item No.	12350	12352	12354	12356	12358	12360	12362	12364

Curved Round - 501 Heavy		
Overall Length	3"	5"
Gauge	16	14
Item No.	12328	12336

Curved Round Point - 501 1/2 Light						
Overall Length	2 1/2"	4"	5"	6"	7"	8"
Gauge	18	16	16	15	15	15
Item No.	12324	12332	12334	12338	12340	12342

Curved Round Point - 501X Extra Light				
Overall Length	2"	2 1/2"	3"	4"
Gauge	1 1/2"	1 3/4"	2"	2 3/4"
Item No.	12350	12352	12356	12358

Straight Needles Round Point



Straight Double Round Point - 505 Light				
Overall Length	10"	12"	14"	16"
Gauge	13	13	13	12
Item No.	12394	12396	12398	12400



Single Round Point - 504 Light					
Overall Length	6"	10"	12"	14"	16"
Gauge	13	13	13	13	12
Item No.	12366	12370	12372	12374	12376

Bayonet Point

Double Bayonet Point - 507 Light				
Overall Length	10"	12"	14"	16"
Gauge	13	13	13	12
Item No.	12406	12408	12410	12412

Single Bayonet Point - 556 Heavy					
Overall Length	6"	10"	12"	14"	16"
Gauge	13	12	12	12	11
Item No.	12380	12382	12384	12386	12388

Regulators and Skewers



Steel Regulators - No. 306 1/2		
Overall	Gauge	Item No.
8"	9	12430
10"	8	12432
12"	7	12434

Plastic Handled Regulator



8"	Item No. 12440
10"	Item No. 12442
12"	Item No. 12441

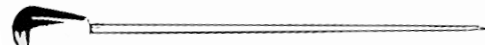

Plastic Head Skewers - No. 193		
Colour	Qty/box	Item No.
Red	100	12422
Blue	100	12424
Yellow	100	12426

3" Steel Upholstery Skewers - No. 190

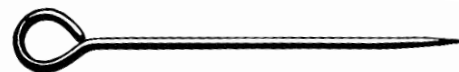

Item No. 12420
1 Gross (144)

HANDY BUTTON DIES



Two Piece Dies

- for use with Junior No. 1 Machine
- choose regular or heavy
- short cutter included



Short Cutter

- cutter works conveniently with Junior No. 1
- made of hardened steel

Button Size	Regular Two Piece Die Set includes short cutter (normal weight fabrics)	Heavy Two Piece Die Set includes short cutter (thick material or expanded vinyl)	Short Cutter Only
22	14140	14142	14170
30	14144	14146	14172
36	14148	14150	14174
45	14152	14154	14176
60	14156	14158	14178



Three Piece Dies

- for use in all swivel type machines
- two types to choose from
- long cutter included



Long Cutter

- use with No. 11 Cutting Machine (next page) or a hammer

Button Size	Regular Three Piece Set includes long cutter	Heavy Duty Three Piece Set includes long cutter	Long Cutter Only
22	14190	14191	14210
30	14192	14193	14212
36	14194	14195	14214
45	14196	14197	14216
60	14198	-	14218

HANDY BUTTON MACHINES



No. 1

Junior No. 1

This versatile manually operated covering/cutting machine is our most popular model. Use it with Junior two-piece dies and a shorter cutter for production of about ninety buttons per hour.

A plastic cover-cutting block is included. 22" in height.

Item No. 14110



No. 12

No. 12 Cutting Machine

This cutting machine is for use with automated button machines to help increase production. The rack and pinion design provides you with smooth, easy operation. Use it with our standard long cutters.

The No. 11 comes complete with a fibre cutting block.

Item No. 14130



No. 300 SH

300SH High Output Button Covering Machine

The furniture industry standard. The six station indexing die plate is driven directly by a 1/3 HP 115V braking motor. Use the fingertip variable speed control to produce from 400 to 2,500 buttons per hour.

Complete with an automatic button counter, safety shield, aluminum shell hopper and enclosed button collection system.

All this power in a compact 31" x 51", with a 35" table height.

Item No. 14122

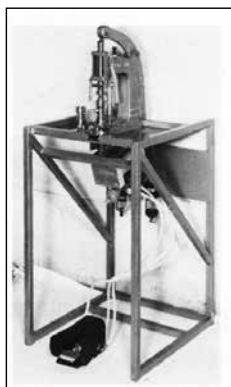

No. 5 PA

5 A Semi Automated Button Machine

You will eliminate operator fatigue and produce about 550 buttons per hour while providing uniform power pressure for consistently tight buttons.

Uses 3 die set

Overall height is 47"

Item No. 14116

STAPLERS & TACKERS

Haubold PN 1416



- our best pneumatic tacker
 - German engineered for durability and accuracy
 - uses 14 series staples
- Item No. 12954**

Fasco F1B

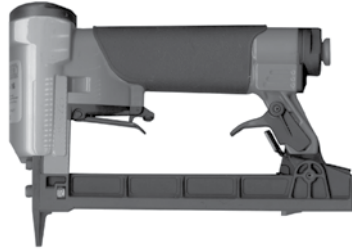

- the work-horse
 - drives 14 series staples (F1B 14-16)
- Item No. 12952**
- drives 71 series staples (F1B 7C-16)
- Item No. 12950**
- long nose version (not shown)
 - drives 71 series staples (F1B 7C-16)
- Item No. 12943**

BeA Stapler



- sturdy construction
 - lightweight and reliable
 - best gun for 71 (S3G) series staple size
 - long time standard for large and small operations
- Item No. 12947**

DUO-FAST AWC 5018S Stapler



- drives 508 (wide crown) staples
 - also available to drive 308 and 3118 wide crown series staples
- Item No. 12944**

DUO-FAST Electric Stapler

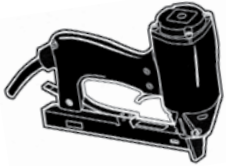

- weighs just 4lb. 3 oz.
 - plugs into any 115V socket
 - uses 3108 series staples
 - also available in crown series for 308, 348 or 508 staples
- Model # EIB 3118
Item No. 12930

Decorative Nail Bulk Feed Nail Gun

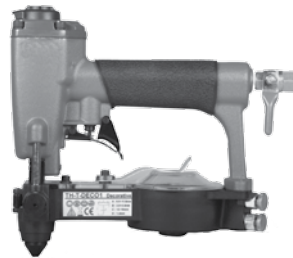

- holds 90 single nails (sizes 9 or 1009)
- up to 125psi ensures centered and properly spaced nail head look with consistent application
- remove from air flow when not in use

Item No 14097

Fasco 11127F Brad Nailer

air operated
for 1/2" to 1 9/16" 18 Ga. brads
Item No. 12306

Brads (5,000 / box)
18 gauge

3/4"	12309
1"	12308
1 1/4"	12310
1 1/2"	12312
1 3/4"	12307

1/4" Series Air Line Accessories



Synflex Hose

- order correct coupler separately
- male threaded brass swivel fittings at both ends
- complete with protective pig tails

25' - Item No. 13017

15' - Item No. 13013



"T" Coupler

- brass
- female fittings
- male fittings

Item No. 13006

Item No. 13004



Automatic Coupler - 2 sizes

140 Type (C38 Amflo)

- interchangeable with Aro Speed 53 Series
- plated steel

Item No. 12986

(use 1401 coupler plug)

150 Type (C20 Amflo)

- interchanges with Hansen and Milton 23 Series
- plated steel

Item No. 12992

(use 1501 coupler plug)



1501, 1502 Coupler Plug

- with short nose, for 150 type coupler
- plated steel

Male 1501 (CP21) Item No. 12994

Female 1502 (CP20) Item No. 12996



Brass Hose Barbs

Male 125 Item No. 12998

Female 126 Item No. 13000

Brass 1/4" Hose Connector

(Use with Clamps 13014)

Item No. 13001



1401, 1402 Coupler Plugs

- with long nose, for 140 type coupler
- plated steel

Male 1401 (CP37) Item No. 12988

Female 1402 (CP38) Item No. 12990

Polyurethane Hose

- self storing - will not crimp
- 15' length comes complete with male fittings and pigtail ends

Item No. 13013



1/4" Clear PVC Air Hose

- nylon reinforced
- order 100' rolls or cut lengths

Item No. 13010



Amflo Blow Gun

- safety model to prevent buildup of tip pressure
- chrome plated

Item No. 13008

Extended Nozzle

Item No. 13007

Hose Clamps

Item No. 13014



A Sample Configuration

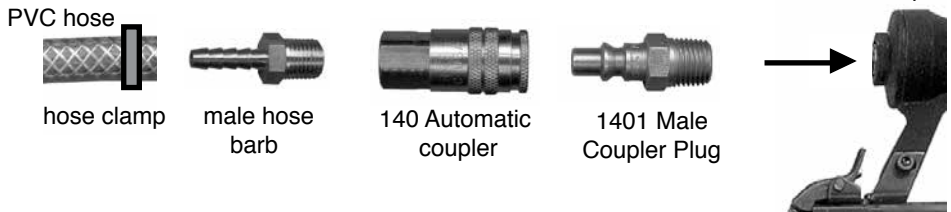

3/8" x 50' Polyurethane Air Hose Reel

- Mounting Bracket allows you to mount the Hose Reel to a Wall, Workbench or Ceiling
- Includes wall /ceiling mounting brackets.
- Closed Cover Retractable Air Hose Reel
- Lightweight and corrosion resistant design
- Spring Driven
- Spring Protector keeps hose from damage when pulled and stretched

Item No. 13005

SPRAY GUNS

CRITTER "Syphon Type" 118 Glue Gun

An ideal and inexpensive way to spray foam fabricating cement, silicone or Fabrigard.

For best results with lighter liquids, reduce your air pressure to 35 psi (easily controlled with a regulator and pressure gauge - see above).

NOTE: This spray gun is white metal. **DO NOT TWIST OFF**

USING THE GUN BODY when refilling. Use lid top to open. Complete Gun Item No. 10676.

If using Zytek Foam Adhesive or any other methylene chloride based glues or solvents, you must use a stainless steel liquid tube, our Item No. 10691. Normal stock tube will corrode.



Item No. 10676



To Maximize efficiency in the shop, let us install a regulator and air gauge on your glue gun.

REPLACEMENT PARTS FOR THE 118 GLUE GUN

SPECIAL ORDER			STOCK PARTS					
Ref #	Name	Part No.	Ref #	Name	Part No.	Ref #	Name	Part No.
1	Air Inlet Union	70606	4	Air Valve Spring 20708	10683	13	Jar Gasket 21525	10686
3	Air Valve Cap	20918	8	Air Nozzle 21038	10679	14	Glass Jar 20223	10678
5	Air Valve	20950	9	Liquid Nozzle 20621	10680	15	Liquid Tube 20217	10682
6	Trigger	20206	10	Nozzle Spring 20710	10681	17	Valve Disc Cap 31006	10689
7	Swivel Pin	61401	11	Locknut 20220	10684	19	Valve Disc 31009	10688
16	Packing	21518	12	Cover Plate	10685	19	Jar Ring	10687
20	Robertson Machine screw #8-32 x 1/4"		20			9A	Stainless Steel Liquid Tube 20218	10691

Air Regulator

- regulates air pressure to keep near constant outlet pressure under all operating conditions
- highly recommended to use in conjunction with our 118 glue gun (see above)
- complete with 160 psi gauge

Item No. 13039



Adapter D 122-BA

- for #118 spray gun
- male thread for 1/4" fit

Item No. 12993



3/8" x 3/8" Male Adapter

Item No. 12997

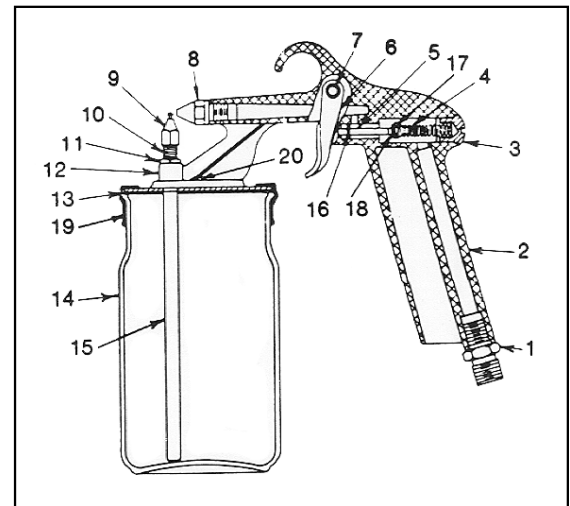



Foam Cutter Body Only

Item No. 13960

Foot Plate Only

Item No. 13968

Bosch 1575 Foam Cutter

- 5", 8" or 12" cutting depths
- slim and compact
- 9 1/4" in length, weighs 3.5 lbs.
- 3,200 strokes per minute
- 115v - AC powered
- order blades and guide separately
- order foot plate with rollers separately

Item No. 13968

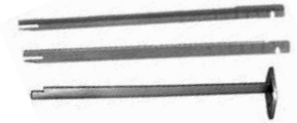

Length	Blades	Guide
5"	13961	13964
8"	13962	13965
12"	13963	13966
Blades sold in pairs		



TDL-100 Fabric Cutter

- 4" octagonal blade
- cuts a single piece of fabric, or a stack up to 1" high
- carbide tipped, spring loaded blade prevents jamming
- single stone sharpening mechanism
- extra thin base plate and light die cast design
- makes the 6.4 lb. TDL-100 easy to operate

Item No. 13980



Air Hog Ring Power Tool - "C" Point

- Uses magazine style hog rings (Item No. 11884) Automatically!
- Work Faster - Consistent pressure ensures maximum closure

Item No. 13038

"D" Point 3/4" Hog Rings

Magazine load for air-powered gun, pictured above 10,000 per carton

Item No. 11884

"C" Point 3/4" Hog Rings

- 10,000 per carton

Item No. 11885



Master HG-501A-D Heat Gun

- 12 amp. 120 VAC.
- produces 500°F to 750°F of heat
- adjustable non-slip stand
- 1500 watts of power

Item No. 14049



G-766 Hot Melt Glue Gun

- heavy duty electric glue gun
- 80 watts
- patented trigger-feed mechanism regulates glue flow
- retractable front stand keeps tool upright when not in use
- standard 1/2" diameter

Item No. 14095

15" Heavy Duty Glue Sticks

- standard 1/2" diameter
- milky colour
- superior hold
- 1 pound box - 12 sticks per pound

Item No. 11863

15" Clear

- for gimp and appliqué

Item No. 11867

MACHINES

EZE Cushion Stuffer

A powerful table top vacuum machine to make cushion filling simple and effortless. Cover cushion with "silk film" (see below), draw down, insert casing over foam and release.

Item No. 14274

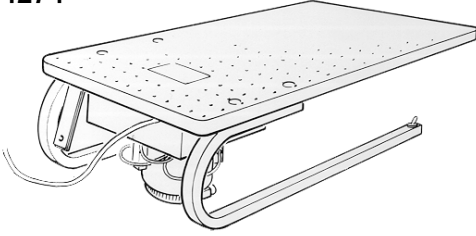

Silk Film

- 30 lb. roll - 54" width **Item No. 14275**
- 60 lb. roll - 54" width **Item No. 14276**
- 60 lb. roll - 42" width **Item No. 14277**



Crypton® Extraction Type Cleaner

- special type cleaner when used with Crypton® concentrate to speed up the job
- highly efficient motor, 2 gallon capacity
- specially calibrated cleaning wand with light weight, see-thru handle

Item No. 23195

"JIFFY" PROFESSIONAL STEAMERS

Both feature automatic shutoff thermostat control and secondary fuse back-up system - to prevent burnout of the heating element. Indicator lights for ON/OFF.

Mounted on casters. Use cold fresh tap water. 115v to make steam in less than a minute.



VHA

Vertical Hose Attachment to eliminate problems of condensation is included.

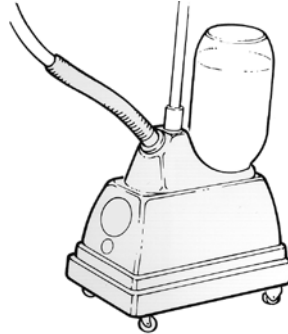

J 2 - Jiffy Steamer

- 3/4 gallon visible PVC water supply
- lightweight plastic nozzle

Item No. 13948

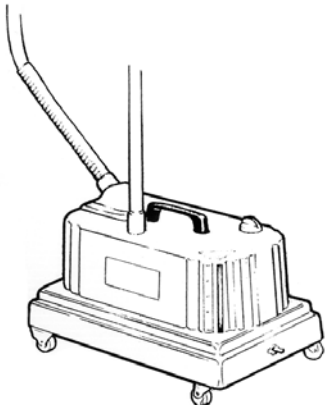

J-4000 M Jiffy Steamer

- metal steam head with visible water gauge
- larger tank capacity - a full one gallon

Item No. 13947

Replacements Parts for Jiffy Steamer	
Name	Item No.
Jiffy J-2 Heating Element Kit with wires (3 piece kit no wires also available)	13949
Jiffy J-2 Toggle Switch	13953
Jiffy J-4000 Heating Element	13942
Jiffy J-4000 L170 Thermostat	13943
Jiffy J-4000 L220 Thermostat	13944
Jiffy J-4000 Silicone Sealer	13945
Jiffy J-4000 Hose Attachment Assembly	13949
Jiffy J-4000 Switch and Knob	13955
Jiffy Steam Head Replacement Assembly	13951
Jiffy Fusible Link Wire J-4 w/lug (8/16 ga. wire)	13954
Pilot Light for Jiffy Steamers	13956

GROMMET SETTING TOOLS



No. 216

Grommet Setting Tool

- dropped forge steel
- 2 piece punch and die set

Type	0	1	2	3	4
Sheet	14072	14074	14076	14078	14081
Spur	-	-	14075	14077	14083

We also stock the "Press-N-Snap" Setting Tool which sets # 1 grommets

See page 84 for ordering details.



Dead Blow Hammer

- all rubber encased
- non-slip handle
- helps to preserve dies
- head is full of beads for powerful blows
- 2 3/4 pounds
- (also available in 4lb weight)

Item No. 13897



PM-5

PM-5 Bench Press

- for setting dome fasteners and sheet grommets

Item No. 14280

(NOTE: The PM-5 will NOT set spur grommets)

Grommet Dies and Cutters for PM-5

Size	00	0	1	2
Cutting Dies	-	14295	-	14290
Grommet Dies	14281	14282	14283	14284

Dies for Setting Dome Fasteners for PM-5

Dies for 670 Item No. 14293

Dies for C548 Item No. 14294

Dies for 550 Item No. 14291



No. 500

Hole Cutters

Size	0A	1A	2A	3A	4A
Diameter of Hole	1/4"	9/32"	11/32"	7/16"	1/2"
Item No.	14060	14062	14064	14066	14080

No. 147 Belt Punch - No. 2, 1/8" dia. Item No. 13920

* See page 86 Press-N-Snap *

Brass Ventilator

- packed in 100's or 1,000's
- 3/4" dia.
- 3/16" shank

Item No. 11854

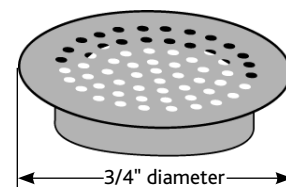

Steel Washers for above Ventilators

Item No. 11855

Ventilator Setting Tool

- 3/4" - fits our stock ventilators
- 2 piece

Item No. 14090

Ventilator Dies

- for use with Handy # 1 Button machine

Item No. 14086



No. 621

MARINE TRIM

TRIDEN MARINE TOPPING - ROLLS OR CUT LENGTHS

TOP GUN

- 11 oz / sq. yd. - 100% polyester
- water repellent, mildew and U.V. resistant
- 62" wide 20 modern colours

Odyssey

- 100% polyester
- 6.5 oz
- great mooring cover
- 18 colours

SUNFORGER

- waterproof
- heavy duty finish
- pre shrunk breathable 100% Cotton duck
- 2 popular colours
D50 Natural, D36 Pearl Grey
- 50 yard rolls

Order your Marine Catalogue Today!

We issue this every early spring. If you would like to receive this automatically, give us a call today and we will make sure your new copy arrives as soon as it is published!

COASTGUARD Marine Fabric

- 100% solution-dyed acrylic
- 60" wide
- 30 colours including 6 tweeds

Fibreglass Tent Screening

- 48" wide
- 33 yard rolls
- black and gray

Clear or Tinted Window Vinyl

- 54" wide, 30 yard rolls
- U.V. radiation resistant

20 gauge Clear F.R.
20 gauge Light Smoke F.R.
20 gauge Dark Tinted
30 gauge Clear F.R.
30 gauge Dark Tinted

COLUMBIA II Marine Carpet

- 100% Olefin pile, 96" width
- mildew and moisture resistant
- U.V. light stabilized
- for direct glue-down installations
- no fuzzing or pilling
- 11 popular colours plus five plush premium 2 tones

Also Available

- Holiday
- Mustang
- Top Notch
- Vista

Ask for a card

Strataglass™ Press Polished Sheets

Strataglass™ Press Polished sheets are manufactured of thermoplastic vinyl material treated with a durable highly polished finish to form a flexible, press polished optically clear sheet. Exceptional weathering capabilities, superb dimensional stability and durability make Ultrashield® the obvious choice for all of your premium job applications.

Available in 30 gauge sheets measuring 54" x 110".

Call our Order Desk for more details about this exciting product.

Ask about these products: Odyssey, Sea Mark, VISTA, Recacril

BOAT TOP FRAME KITS

All of our boat frame kits are 7/8" bright aluminum tubing. Each frame kit comes complete with 4 buckles, 2 webbing clips, 2 eye straps and die cast fittings including jaw slides, socket ends and flat deck mounts. Just order the marine fabric of your choice and polypro webbing and you are ready to start! All tops are UPS shippable.

Standard Boat Frame Kit

- adjustable to 80" wide, 43" high

Item No. 42820

Large Boat Frame Kit

- adjusts up to 98" wide, 60" high

Item No. 42822

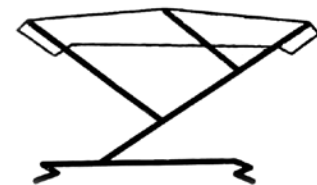

Bimini Type Top

- with 2 floating bows
- adjusts up to 96" wide, 60" high

Item No. 42824

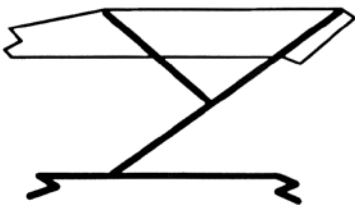

Jaw Slide**Socket End****Jaw Slide****Socket End**

BOAT FRAME PARTS

Polypro Webbing

- 1" polypropylene - 100 yard rolls

White Item No. 45118**Black** Item No. 45100

	Diecast	Black Nylon		White Nylon		Stainless Steel		Square Tubing	
Tube Diameter	7/8"	3/4"	7/8"	3/4"	7/8"	7/8"	1"	Black	White
Jaw Slide	42150	42400	42500	42450	42600	42042	42044	42622	42621
Socket End	42160	42410	42510	42460	42610	42040	42043	42624	42623

Aluminum Tubing

Stainless Steel Tubing	Wall Diameter	Item No.
7/8" diameter, 20 ft. length	.049	42991
7/8" diameter, 24 ft. length	.049	42990
1" diameter, 20 ft. length	.049	42992

Stainless Steel Tubing Bright Dipped Finish	Wall Diameter	Item No.
3/4" diameter, 20 ft. length	.058	42955
7/8" diameter, 24 ft. length	.058	42966
7/8" diameter, 20 ft. length	.058	42965
7/8" diameter, 12 ft. length	.058	42960
7/8" diameter, 10 ft. length	.058	42970

Square Pontoon Boat Tubing Satin Finish	Wall Diameter	Item No.
1" Square, 20 ft. length	.062	42973
1" Square, 24 ft. length	.062	42972

Metal Slide Track

7 feet Item No. 42843

14 feet Item No. 42842

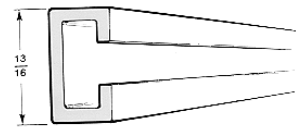
**Nylon Track Slider**

Item No. 42760

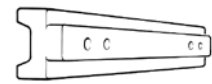
**Slide Track End Cap**

- Black nylon

Item No. 42764

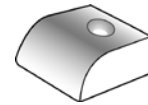
**Tube Connector**

- for 7/8" tube

Item No. 42525

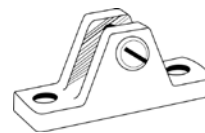
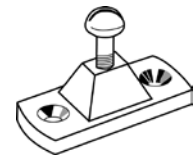

		Diecast	Black Nylon	White Nylon
Deck Mount Plate	Angled	42190	42540	42640
	Flat	42180	42530	42630
Side Mount Plate		42200	42550	42650

**Deck Mount Plate****Side Mount Plate****Support Poles**

- 25" Pole
- expands to 48"
- with Multi-Use Ends

Item No. 42701

- 31" Pole
- expands to 60"
- Multi-Use Ends

Item No. 42703

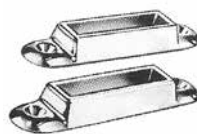

multi-use ends for grommets or snap fasteners

**Bow Sockets**

black nylon

Item No. 42242

white nylon

Item No. 42243

chrome die-cast

Item No. 42240

Sunblocker Clip

fits 7/8" tubing

Item No. 42220

double clip for 7/8"

Item No. 42221

fits 1" tubing

Item No. 42222

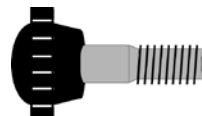
**Thumbscrew**

Item No. 42700

Quick Release Pins

with lanyard Item No. 42085

pin only Item No. 42086



MARINE UPHOLSTERY

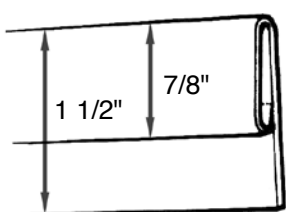

Stop Leak
 Made of PVC
 Sew to seam to keep water out
 300 yard rolls or cut to suit
 White **Item No. 11534**
 Black **Item No. 11535**



Ventilator
 • white flexible PVC
 • easily sewn on to rear curtain to help air flow
Item No. 11538 - Clear
Item No. 11539 - Black

1" Supported Vinyl Bias Binding

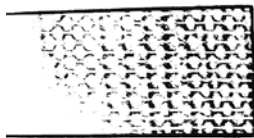

slit from double coated vinyl material
 75 yard rolls
 Black **Item No. 10147**

#300 Bias Binding - vinyl coated, one edge turned, 1 1/4" wide

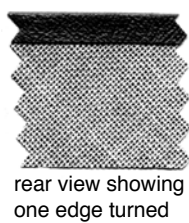

- | | | | | | | | |
|------------|--------------|---------------|--------------|--------------|--------------|----------------|--------------|
| 301 red | 10122 | 309 white | 10120 | 324 camel | 10134 | 302 royal blue | 10124 |
| 318 maroon | 10128 | 325 dark blue | 10136 | 306 saddle | 10126 | 321 tobacco | 10130 |
| 329 almond | 10138 | 308 black | 10118 | 323 green | 10132 | 330 firethorne | 10140 |
| 312 silver | 10127 | 316 turquoise | 10129 | 333 charcoal | 10141 | 354 jade | 10142 |
| 311 gray | 10125 | | | | | | |

Acrylic Cloth Binding • 1 1/4" wide 1 edge turned • 100 yard spools (cuts available) We also stock 2 edge turned and 7/8" Acrylic Centre Fold Binding

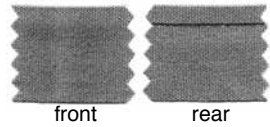

414 Aqua	41798	6117 Blue Tweed	41844	6137 Forest Green	41815	6104 Natural	41832
6152 Baltic Blue	41799	4621 Brown	41808	6130 Grey	41820	6126 Navy	41824
6120 Beige	41836	6131 Burgundy	41812	4600 Green	41816	6103 Red	41828
6108 Black	41800	6144 Charcoal	41813	6105 Green Tweed	41846	6106 Red Tweed	41848
6140 Black Cherry	41822	6107 Charcoal Tweed	41814	421 Light Blue	41821	6143 Teal	41838
6101 Blue	41804	6170 Dove	41818	6054 Linen Tweed	41823	6110 Turquoise	41847

Extruded Embossed Vinyl Welt



• 100 yard spools • slashed for ease of sewing
Black - Item No. 15584

- | | | | | | | | |
|----------|--------------|------------|--------------|--------------|--------------|-----------|--------------|
| Bone | 15580 | Dark Green | 15589 | Grey | 15583 | Navy | 15585 |
| Brown | 15587 | Dark Grey | 15590 | Medium Blue | 15592 | Off White | 15581 |
| Buckskin | 15591 | Firethorne | 15582 | Medium Brown | 15588 | Tan | 15586 |

Specialty Threads



(described on pages 79-80) are UV resistant and designed for marine applications. Order by colour or tell us the vinyl pattern and colour to match. Try our new Sunguard thread - colour matched to Coastguard and Top Gun marine toppings.

Foamwelt

- 3/32" 1250 yard spool **Item No. 12585**
- 4/32" 500 yard spool **Item No. 12588**
- 5/32" 500 yard spool **Item No. 12591**

Transfer Double Sided Seam Tape

- to hold 2 pieces of fabric together
- 72 yard roll - 1/2" • 60 yard roll - 1/4"
- Item No. 41910** **Item No. 41909**



Separating (open ended zipper)
with reversible (double) tab sliders.

Non Stock lengths are also available. Call for details

Tent and Canvas Customers
For No. 7 Brass or Aluminum Heavy Duty Zipper -
See Auto Trim Page 85

Finished Length	No. 10 YKK® Vision					
	Black	White	Beige	Blue	Burgundy	Gray
18"	16295	16116	-	-	-	-
24"	16300	16120	16545	16400	16450	16500
30"	16305	16124	16549	16405	16455	16505
36"	16310	16128	16555	16410	16460	16510
42"	16315	16132	-	-	-	-
48"	16320	16136	16560	16415	16465	16515
54"	16325	16140	-	-	-	-
60"	16330	16144	16565	16420	16470	16520
72"	16340	16152	16570	16425	16475	16525
84"	16350	16156	16575	16430	16480	16530
96"	16360	16160	16580	16435	16485	16535
108"	16365	16168	-	-	-	-
120"	16370	16175	16585	16440	16490	16540

NOTE: Coloured Zippers Match: Coastguard® TOP GUN

No. 10 Zipper Chain and Accessories

for closed end zipper applications

	Chain 100 meter rolls	Single Tab Slider	Double Tab Slider	Bottom Stop	Top Stop
White	16100	16102	16104	16107	16106
Black	16108	16109	16110	16112	16111



Webbing Accessories

Nylon "D" Ring



For 1" webbing - Item No. 42741
For 1 1/2" webbing - Item No. 42739
For 2" webbing - Item No. 42743

Nylon Side Release Buckle



For 1" webbing - Item No. 42738
For 1 1/2" webbing - Item No. 42747
For 2" webbing - Item No. 42737

Nylon Adjustable Buckle



For 1" webbing - Item No. 42736
For 1 1/2" webbing - Item No. 42745
For 2" webbing - Item No. 42746

MARINE TRIM

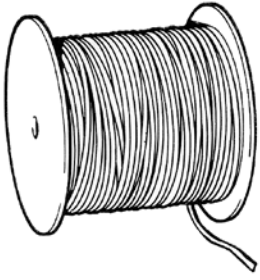

Shock Cord (nylon covered rubber)

3/16" dia.	100' roll	Item No. 12615
3/16" dia.	500' roll	Item No. 12616
1/4" dia.	500' roll	Item No. 12618
3/8" dia.	150' roll	Item No. 12620

Shock Cord Clips



Black Lexan for 1/4" diameter cord.
Hook and collar to fit over cord end.
Item No. 42735

Nylon coated metal hook to hold 1/4" shock cord.
Item No. 42733



Adjustable. Rustproof hook adjusts
in seconds and fits 3/16" or 1/4" cord.
Item No. 42734

METAL BOAT SEAT HINGES

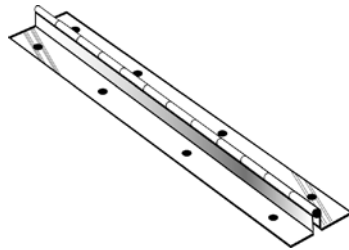
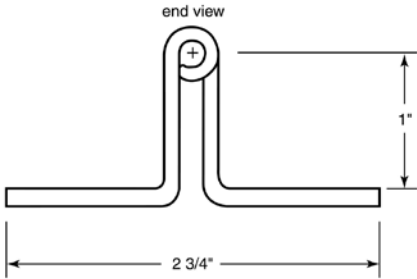

LARGE OFFSET HINGE

- 72" long 1" tall (when closed)
 - 2 1/2" wide
- Item No. 11556**

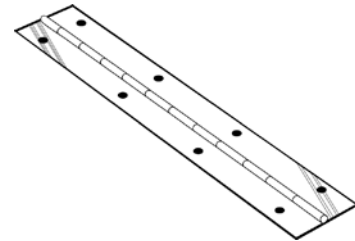

Large Straight Hinge

- 72" long
 - 3" wide folded flat
- Item No. 11555**

Rebond Seat Foam (bonded chip foam)

22" x 72" sheet

- 1" **Item No. 11496**
- 2" **Item No. 11494**
- 3" **Item No. 11492**
- 4" **Item No. 11490**

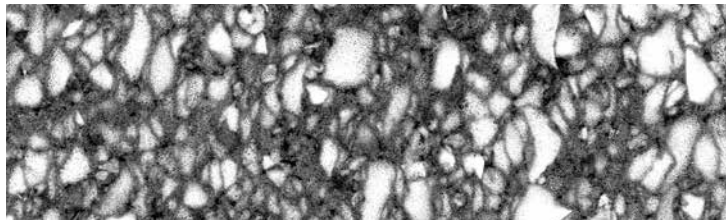

Gaicho "FR"

Stocked for your convenience in pattern # 1 in these popular colours:

Ash Gray	Item No. 30999
Black	Item No. 31000
Blue	Item No. 31002
Chestnut	Item No. 31004
Desert Sand	Item No. 31006
White	Item No. 31008
Wine	Item No. 31010

Quilted Vinyl - Stock Patterns

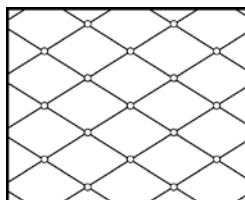

Pattern # 1
4" x 2 1/2" diamonds

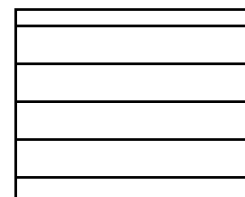

Pattern # 7
1 1/2" bars

We also stock **Admiral Marine Vinyl "Sea White"** in patterns # 1 and # 7 and **Wintersport Black** in pattern # 7

Cotton Duck

Weight	Width	Colour	Description	Item No.
8 oz.	70"	Natural	-	10833
14 oz.	60"	Natural	# 10	10836
10 oz.	60"	Natural	D-50	10858

Fibreglass Window Screening - 48"

Black	Item No. 12654
Gray	Item No. 12652

Heavy Duty Screening - 72"

- for truck tarp / industrial use
- | | |
|-------|----------------|
| Black | Item No. 12659 |
|-------|----------------|

"Cordura" Saddle Bag Nylon

- 61" width
- black

Plain Laminated to 1/8" black foam

Item No. 10867

Item No. 41570

Coverlite

- 61" width
- black

Item No. 41550

Sunscreen Solar Screen Fabric

- up to 90% blockage of the sun's harmful rays
- provides daytime privacy but you can still see out!
- reduces heat transfer to interiors of RV's, cabins of boats, trailers, homes, restaurants, hotels
- reduces fade of fabrics and furnishings
- acts as an insect barrier!
- 100% PVC coated polyester yarn
- flame retardant and wear resistant
- 60" width, 33 yard rolls

Black	Item No. 45700
Desert Sand	Item No. 45703
Gray	Item No. 45704
White	Item No. 45707

Tricover 18 Vinyl Coated

Polyester Scrim

- 18 oz. per square yard total weight
- 61" width
- meets California State Fire Marshall requirements for Flame Retardancy
- mildew and rot resistant
- ultraviolet resistant
- great for truck tarps, industrial covers

Black	Item No. 10906	Red	Item No. 10910
Blue	Item No. 10900	White	Item No. 10908
Green	Item No. 10904	Yellow	Item No. 10902
Gray	Item No. 10905		

We also stock a 22 oz. Black Tricover which is not FAR approved. (Item No. 10898)

Tricover 14 Vinyl Coated

Polyester Scrim

- 14 oz. per square yard total weight
- 61" width
- meets NFPA 701 test requirements for F.R.
- mildew and rot resistant
- ultraviolet resistant
- use for BBQ covers and other light duty applications

Black	Item No. 10913	Royal Blue	Item No. 10922
Camel	Item No. 10916	Red	Item No. 10920
Forest	Item No. 10911	White	Item No. 10918
Maroon	Item No. 10915		

SEAMING & PIPING

T-Braid

- paper welting cord
- enclosed in a nylon mesh for uniformity
- spools or easy to use centre pull cartons



SPOOLS

Size	3/32	4/32	5/32	6/32	8/32	10/32	12/32	1/2
Put Up-yds	1 000	1 000	1 250	900	500	350	225	120
Item No.	12570	12559	12573	12576	12564	12581	12566	12567

Centre Pull Cartons

Size	4/32	5/32	6/32
Yards	2 500	2 000	1 200
Item No.	12580	12582	12579

F.R. Type Smoulder Resistant T-Braid

- has a blue foil insert
- meets UFAC standards
- 5/32" 1,000 yard spool **Item No. 12575**
- 5/32" 2,000 yard centre pull carton **Item No. 12586**
- also available in sizes from 4/32" to 1/2" - inquire for details

5/32" T-Braid Half Spool

- economical 500 yard put-up
- Item No. 12603**

F.R. Type Foamwelt Plus

- reinforced filler
- meets UFAC standards
- 5/32" 1250 yard spool - **Item No. 12593**

Spring Welt

- vinyl covered tight wound steel spring cord
- for semi-attached backs
- 6/32" - 100 foot roll or cuts - **Item No. 12606**

Super Soft T-Braid

- 1/2" - 240 yard spool - **Item No. 12569**
- 1" - 85 yard spool - **Item No. 12568**

Plastic Double Welt

- extruded PVC
- centre staple application
- 5/32" - 250 foot spool - **Item No. 12602**

Double Welt

- 2 T-Braid cords overbraided for double welt sewing
- 4/32" - 350 yard spool - **Item No. 12596**
- 5/32" - 250 yard spool - **Item No. 12598**

Backer Rod

- closed cellular foam for large, soft welting
- other diameters available to special order
- 1/2" dia. - 1,250' spools or cuts

Item No. 10376

3/4" dia. - 1,100' spools or cuts

Item No. 10375

Foamwelt

- 3/32" 1250 yard spool **Item No. 12585**
- 4/32" 500 yard spool **Item No. 12588**
- 5/32" 500 yard spool **Item No. 12591**

Spring Edging

2 - 1 1/4" Jute Edge

1 1/4" dia. paper core, covered with heavy jute designed for ease of sewing to front spring edge
50' Item No. 10942 400' Item No. 10944

2

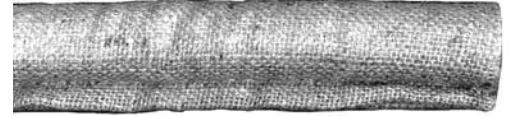

Jute Frame Edging

heavy burlap covered synthetic filled 3 sizes

diameter	1/2"	3/4"	1"
50' roll	10930	10934	10938
full roll length	1,000'	600'	500'
full roll Item No.	10932	10946	10940

Jute Edge Roll

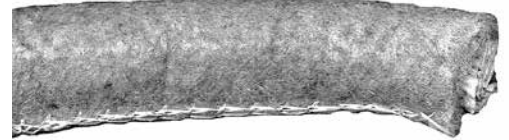

TDL Edge Roll

- white synthetic filled edging
- covered with spunbonded polyester
- generous lip for stapling or sewing
- 1 1/4" has spring edge with lip

diameter	1/2"	3/4"	1"	1 1/4"
50' rolls	10950	10954	10958	10966
full roll length	2000'	800'	600'	400'
full roll Item No.	10945	10946	10947	10965

TDL Edge Roll

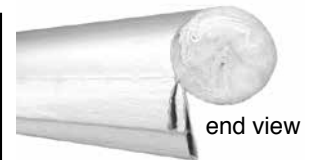

Ring-Flex®

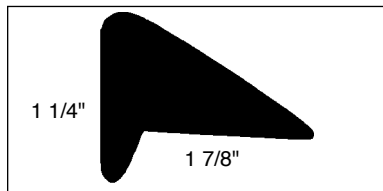

White styrofoam edgings for finishing wooden edges 24 different sizes and shapes inquire for brochure #12 illustrated

50' Item No. 10990
200' Item No. 10992

Trim-Flex™

styrofoam edging
soft and resilient

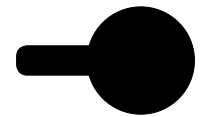

diameter	1/2"	3/4"	1"
50' roll	10994	10998	11002
full roll length	1,000'	500'	500'
full roll Item No.	10996	11000	11004

Rebond Edge

- made of extra firm chip foam
- 72" length,
- 2 sizes

Size	Height	Width	Lip	Item No.
Small	1 1/2"	3"	1/2"	10970
Large	2"	4"	1/2"	10969

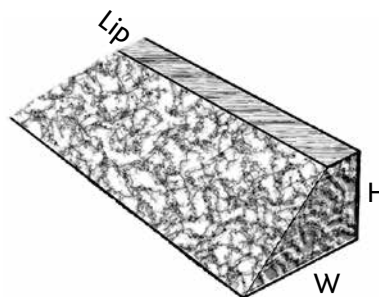

Cushionfoam Edge

- heavy density firm foam edging
- 84" lengths
- 2 sizes

Size	Height	Width	Lip	Item No.
#2	1 1/2"	3"	1/4"	10972
#4	1 3/4"	3 3/4"	1/4"	10974

BED MECHANISMS



Square Tubular Sleep Sofa System by Leggett & Platt

- all tubular construction is safe and strong
- helically suspended polypropylene fabric enhances comfort for both sleeping and sitting
- advanced linkage design for extra easy opening and closing
- dual tubular legs for added strength and reduced floor damage
- mattress retainers included
- mounting height 6 7/8"
- minimum cavity 31 1/2"
- front rail 10 1/2" to 13 1/4"

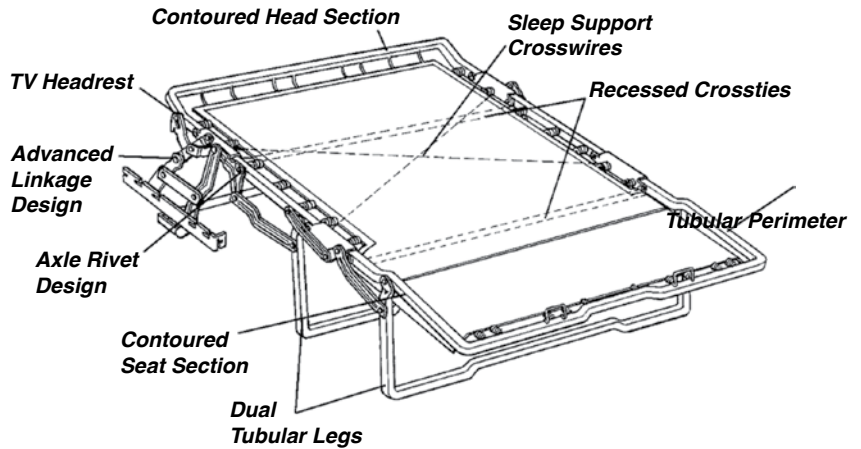

Love 44"	Double 60"	Queen 68"	Queen Deluxe
Item No. 12897	Item No. 12899	Item No. 12901	Item No. 12913

SPRING MATTRESS

(for above bed mechanisms)

- 78" long • 4" thick • Deluxe available

Love 39"	Double 54"	Queen 60"	Queen Deluxe
Item No. 12914	Item No. 12910	Item No. 12912	Item No. 12913

Marshall Unit (Cotton Pocket Unit)

- great for custom backs
- 15 ga. 3 1/2" high
- hog ringed and covered in a non-woven fabric

6 x 6	18" x 18"	Item No. 10820
6 x 7	18" x 21"	Item No. 10822



Build a custom ottoman and install this great bed - Ask for drawings

Tri-Fold Residential Sofa Sleeper System

Available Mounting Sizes:

32" - 81.2cm

44" - 111.7cm

60" - 152.4cm

Width: Unit size minus 7"

Item No. 12900

Mattress Specifications:

Thickness: 2.36" - 2.76" (6cm - 7cm)

Length: 74" (187.96cm)

Mattress - Item No. 12909

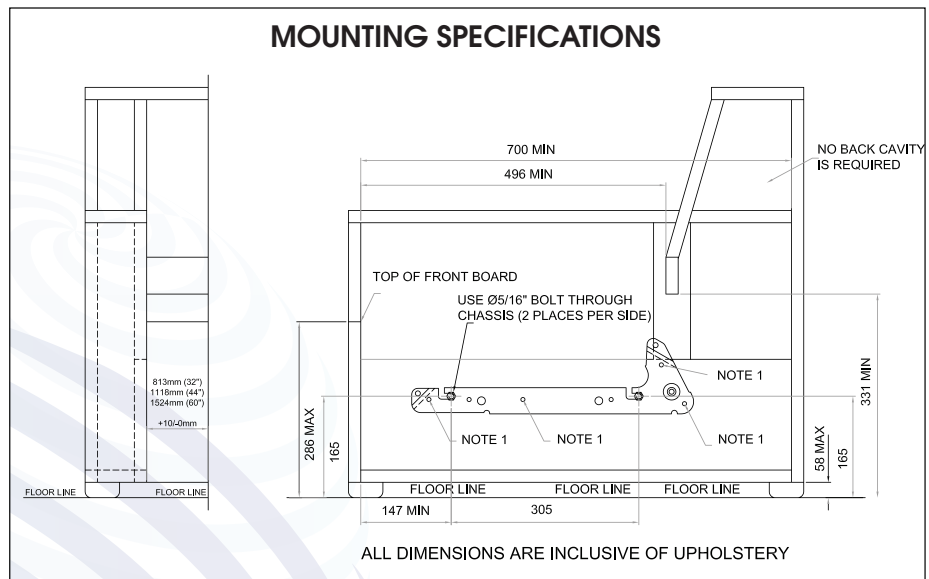

BED MECHANISMS



Futon Hinge

- sold in pairs
- Item No. 12842

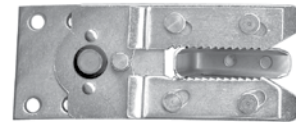

Sectional Joiner

- joins pieces of sectional sofas
- usually requires two per sofa

Item No. 12123

CHAIR BASES - DOMESTIC



RF 105

Swivel Rocker Base

Item No.	"A" Overall Height	"B" Floor to Base
12802	5.5"	2"
12800	7"	3"

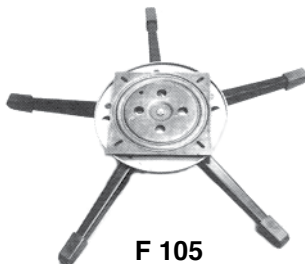
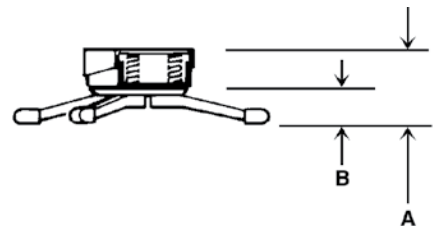

F 105

Swivel Base

- 5 legged chair base
- swivel only

2 3/4" overall height
4 1/2" overall height
6" overall height

Item No. 12822
Item No. 12824
Item No. 12823

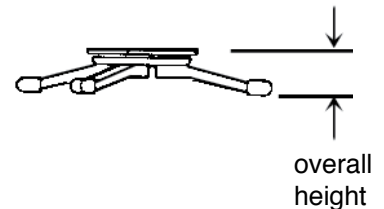

Circular Swivel Base

10" swivel plate
24" diameter, 1 1/2" high
Item No. 12805

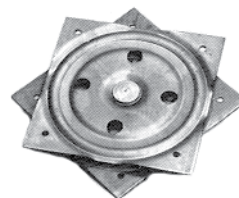

Swivel Plate

7" Item No. 12828
8" (memory) Item No. 12832
10" Item No. 12830

Other sizes are available
by Special Order -
Call the Order Desk for details.



Platform Rocker Springs

- sold in pairs
- 8 gauge

Standard Item No. 12814

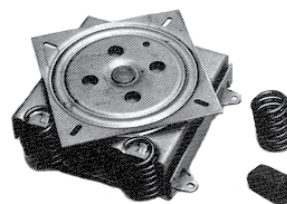

Swivel Rocker
Box only Item No. 12804

Replacement Parts

Rear Spring
(small)
Item No. 12808

Front Spring
(large)
Item No. 12806

Plastic
Feet
Item No. 12810

NO-SAG SPRING

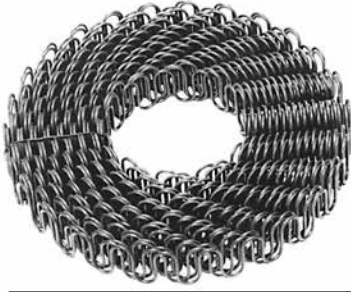

How to Measure **NO-SAG**

Place end of circular No-Sag spring on a yardstick. Roll back until it lies flat. The distance between the outside of each end is the correct length.

- Reference Table 1.**
1. To Determine Number of No-Sag strands.
 2. Estimate proper spacing of clips.
 3. Choose the correct length of connecting links.

Distance Between Arms along Front Seat Rail	1. Number of No-Sag Strands	2. Centre to Centre Spacing for Clips	Centre Spring of two outside clips from inside arm posts.	3. Connecting Link Length
21" Chair	5	4 1/4"	2"	2 5/8"
22" Chair	5	4 1/2"	2"	2 7/8"
23" Chair	5	4 3/4"	2"	3 1/8"
24" Chair	5	5"	2"	3 3/8"
25" Chair	6	4 1/4"	1 7/8"	2 5/8"
40" Sectional	9	4 1/2"	2"	2 7/8"
50" Love Seat	11	4 1/2"	2 1/2"	2 7/8"
52" Love Seat	11	4 3/4"	2 1/4"	3 1/8"
58" Sofa	12	5"	1 1/2"	3 3/8"
59" Sofa	12	5"	2"	3 3/8"
60" Sofa	13	4 3/4"	1 1/2"	3 1/8"
61" Sofa	13	4 3/4"	2"	3 1/8"
62" Sofa	13	4 3/4"	2 1/2"	3 1/8"
63" Sofa	14	4 1/2"	2 1/4"	2 7/8"
64" Sofa	14	4 1/2"	2 3/4"	2 7/8"
65" Sofa	14	4 3/4"	1 5/8"	3 1/8"
66" Sofa	14	4 3/4"	2 1/8"	3 1/8"

How to Measure Frame and Determine Arc

1. Measure the frame inside to inside - front to rear on seats and top to bottom on backs. If clips are **NOT** being mounted on inside of frame (normal) measure length between clips.
2. Use **Table 2** (below) to determine correct gauge and length of No-Sag.

Reference Table 2 - Determining Gauge and Length of No-Sag.

Seats

Inside Seat Dimension	No-Sag Gauge	Length	Inside Back Arc
17"	9	16 3/4"	1 5/8"
18"	9	17 3/4"	1 3/4"
19"	9	18 3/4"	1 3/4"
20"	9	20"	1 7/8"
21"	9	21"	1 7/8"
22"	8	22"	1 7/8"
23"	8	23"	2"
24"	8	24"	2"
25"	8	24 7/8"	2"
26"	8	25 3/4"	2"
27"	8	26 3/4"	2"

Backs

No-Sag Dimension	Gauge	Length	Arc
16"	12	16"	1 1/2"
17"	12	17"	1 5/8"
18"	12	18 1/4"	1 3/4"
19"	12	19 1/4"	1 7/8"
20"	12	20 1/4"	2"
21"	12	21 1/4"	2"
22"	12	22 1/4"	2"
23"	12	23 1/2"	2 1/4"
24"	11 or 12	24 1/2"	2 1/4"
25"	11 or 12	25 1/2"	2 1/2"
26"	11 or 12	26 1/2"	2 1/2"

Tools to help shape No-Sag on pages 42, 44

no-sag Coils

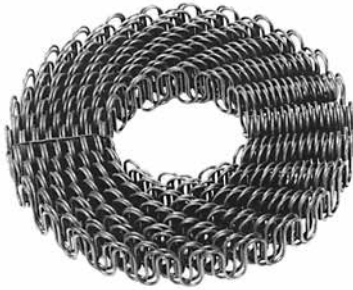

Gauge	8 ga	9 ga	11 ga	12 ga
Length	111'	120'	140'	154'
Item No.	12700	12702	12706	12708

9 ga. 24" length pre-cut pieces **Item No. 12712**

8 ga. 27" length pre-cut pieces **Item No. 12713**

other sizes are available - call for details



Connecting Link

to connect No-Sag strands to stiffen platform
sold by the pound - approx. 100/lb.

Length	2 1/2"	3"	3 1/2"	4"
Item No.	12776	12778	12780	12782



No-Sag

Ardox Spiral Nails

sold by the pound

Item No. 12790

CLIPS for Springs

Note: All clips are sold per 100



KG 722 Staples
for use with EKS clips
7/8" - 20,000/box
Item No. 12761



EK-S Clip
use with KG 722 staples
Item No. 12762



EK Clip
Item No. 12760



G Clip
to drop spring 1"
Item No. 12764

Hinge Links



moveable pivot makes higher arc
possible - up to 2 1/2"
• allow for length of link before cutting No-Sag

Item No. 12774

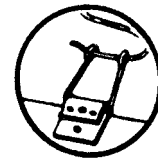

Hinge Link
with E.K. clip

SEAT and BACK HELICALS



**Open Wound
Back Helicals**

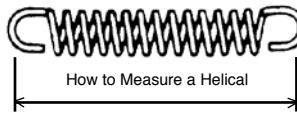

**Close Wound
Seat Helicals**



Length	2"	2 1/2"	3"	4"	C.W. →	2"	2 1/2"	3"	4"
Item No.	12746	12748	12750	12754	← O.W.	12734	12736	12738	12740

Bed Helical Springs



3/4" x 1 3/4" **Item No. 12755**
3/4" x 2.5" **Item No. 12756**

COIL SPRINGS

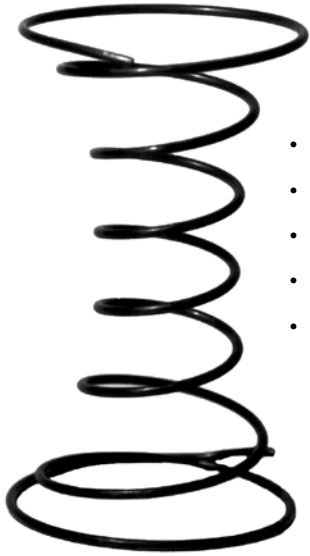

Open End Springs

- tempered wire
- 5" top, tapering to a 2 1/4" throat
- 4 1/2" base
- 40 pieces per bundle
- 3 styles to choose from:
 - open end
 - knotted one end
 - knotted both ends

Knotted Springs

8" x 8 Ga. Knotted one end
Item No. 12677

Other sizes are available
by Special Order



OPEN END

Height	5"	6"	7"	8"	9"	8"	9"	10"
Gauge	9	9	9	9	9	8	8	8
Item No.	12670	12672	12674	12676	12678	12680	12682	12681



Klinch it Tool
Page 42

Coil Springs are available on a special order basis in 10" and 11" heights.

To tie up your springs, use Tuff Twine - Page 78

PRE-FORMED SPRINGS

Soft Edge Seat Spring

- to make a quick and easy soft edge
- stock 30" 8 ga medium loop (shown)

Item No. 12720

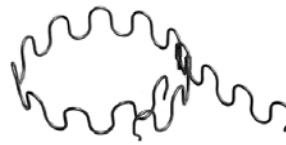

*Other lengths and gauges available in either type of spring.
Call our ORDER DESK for more details.*

Torsion Spring (Double Turn)

- to stiffen corners and edges
- 50 in a box

Item No. 12730

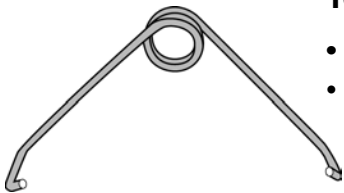

13 Gauge Zinc Plated Wire Spring-Up Nails

13 gauge, 7/8" large head nail

1 pound

Item No. 13331

50 pound carton Item No. 13405

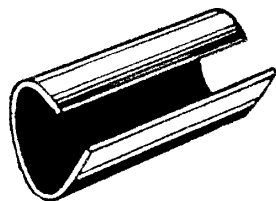

BW (C) Clip

- 7/8" length
- lined for silence
- 1/4" gap when open

Item No. 12766



3 Prong Edge Wire Clip

- lined to eliminate squeaking.
- 100's & 1,000's

Item No.12768



Hartco Clips

- for air operated tools
- 5,000 per box

Item No. 12770

Edge Wire

- tempered steel
- 9 ga.
- 9' lengths
- sold separately or 25 per bundle.

Item No. 12846

Paper Covered Wire

2 styles available

12 ga

- 9' lengths
- each or bundles of 25

Item No. 12845

15 ga

- full spools only
- 50 lbs / spool

Item No. 12844



Flexcon

- 15 Gauge
- stiff wire enclosed in black composite
- ideal for specific seating assemblies

4000 ft roll - Item No. 12849

Precut 17 1/2" - Item No.12848

The Standard Soft Edge

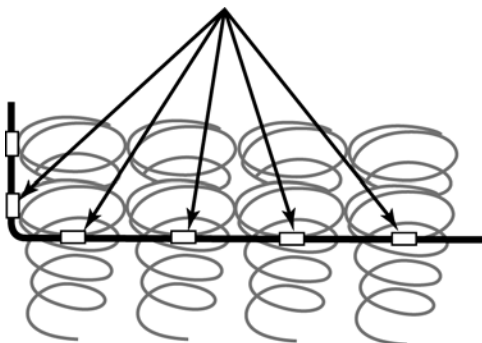

Use the accessories on this page to make a soft edge, as shown above. The edge wire (in black) is secured to the coil spring with either a BW or a 3 prong clip (arrowed).

WEBBING

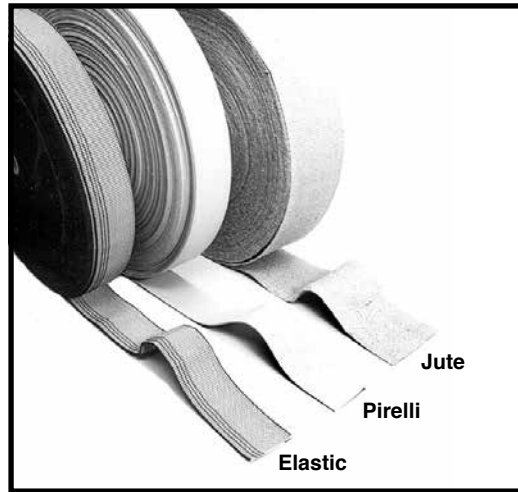

Elastic # 350

- 2" elastic
- 80% stretch for use in both seats and backs
- 164' rolls

Item No. 15631

Elastic # 370

- heavy duty 2 3/4" elastic
- 70% stretch for use in seats
- 164' rolls

Item No. 15635

Elastic # 450

- heavy duty 2" elastic
- 70% stretch for use in seats
- 164' rolls

Item No. 15632

BW 170

- 2 3/4" elastic
- 70% stretch

Item No. 15631

FW 370

- 2 3/4" elastic
- 30% stretch

Item No. 15642

Pirelli Rubber Webbing

- for Scandinavian type furniture
- 100' to a roll
- 2" wide
- cut lengths or full roll

Item No. 15612

Jute Webbing

- 9 lb. roll. 3 1/4" wide
- 72 yards to a roll

Item No. 15600

Item No. 15601 - 10lb 3 1/2"

Polyweb Polypropylene Back Webbing

- 3 1/2" wide
- 114 meter rolls

Item No. 15606

Webbing Clip

- insert type for rubber webbing
- 2" size
- 100 per pack

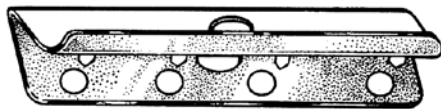

Item No. 15616

Elastic for Sewing

Colour	1/4"	1/2"	1"
Black	-	10979	10981
White	10983	10980	10982



Flex-Web Elastic Webbing

- available in both 2" (50 mm) and 2 3/4" (70mm) widths
- "FW" is a blend of modern yarns for greater strength
- "BW" is a monomer elastic
- the percentage stretch is how much you can pull the webbing

2 Popular Sizes

Style	Width	Percentage Stretch	Item No.
BW 170	2 3/4"	70%	15645
FW 370	2 3/4"	30%	15642

Office Chair Back Protectors

- extruded clear plastic
- 250' per roll

Item No. 10774

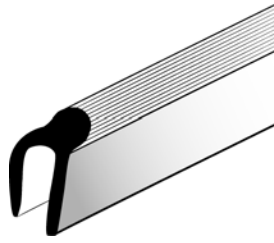

Clear Plastic Covers

Protect finished furniture for shipping with our clear plastic 1.25 mil poly covers. 100 to a roll or individually.

Description	Size	Item No.
Sofa Cover	135" x 42"	10770
Chair Covers	78" 42"	10772
Love Seat	96" x 42"	10771
Office Chair	51" x 42"	10773

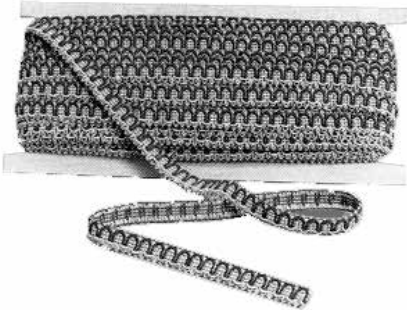

Scroll Gimp

Manufactured of high quality durable rayon, our scroll gimp is the perfect choice to accent upholstered furniture.

- put up on 36 yard cards
- over 30 different colours to choose from

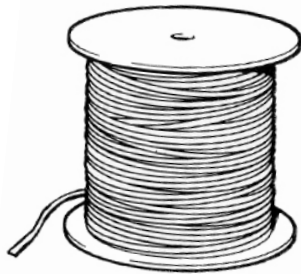

Twill Tape

- re-enforcing for edges and backing for french seams
- put up in 100 metre spools

Description	Size	Item No.
1" Twill Tape Cotton - Black	100 MT/RL	10169
1" Twill Tape Polyester - Black	100 MT/RL	10170
1" Twill Tape Polyester - White	100 MT/RL	10172
3/4" Twill Tape Cotton - Black	100 MT/RL	10175
3/4" Twill Tape Cotton - Black	100 MT/RL	10177
3/4" Twill Tape Cotton - White	100 MT/RL	10178
3/4" Cotton Twill Tape - Natural	100 MT/RL	10181
3/4" Twill Tape Polyester Black	100 MT/RL	10188
5/8" Twill Tape Cotton - White	100 MT/RL	10173
5/8" Twill Tape Cotton - Natural	100 MT/RL	10174
5/8" Twill Tape Polyester Black	100 MT/RL	10171
3/8" Cotton Twill Tape - White	500 MT/RL	10179

BeA[®] Brand Staples



BeA 3371 Air Tacker
Item No. 12947



Fasco F1B 7C-16
Item No. 12950

BeA[®] Brand GALVANIZED 71 Series (S3G) Staples

• The BEST for your **BeA** Tacker

Type	Length	Quantity/Box	Boxes/Carton	Item No.
71/5	3/16"	10,000	24	13041
71/6	1/4"	20,000	18	13049
71/8	5/16"	20,000	12	13063
71/10	3/8"	20,000	12	13052
71/12	1/2"	20,000	12	13055

STAINLESS STEEL 71 Series (S3G) Staples

• for outdoor seating, boats, etc.

Type	Length	Quantity/Box	Boxes/Carton	Item No.
SS 71/06	1/4"	10,000	20	13051
SS 71/10	3/8"	10,000	20	13045
SS 71/12	1/2"	12,000	20	13044

FASCO Brand Staples

FASCO Galvanized 71 Series (S3G) Staples

Type	Length	Quantity/Box	Boxes/Carton	Item No.
71/6	1/4"	10,000	20	13120
71/8	5/16"	10,000	20	13121
71/10	3/8"	10,000	20	13122
71/12	1/2"	10,000	20	13124

FASCO Narrow Crown Staples

Type	Length	Finish	Quantity/Box	Boxes/Carton	Item No.
4110 (ESA)	3/8"	Galvanized	10,000	10	13188
4112 (ESA)	1/2"	Galvanized	10,000	10	13192

Wide Crown GALVANIZED Staples to fit FASCO/RAINCO F1B 50-16

Type	Length	Quantity/Box	Boxes/Carton	Item No.
508	1/4"	5,000	20	13170
5010	5/16"	5,000	20	13172
5012	3/8"	5,000	20	13174
5016	1/2"	5,000	20	13176

14 Series Staples for haubold® Tackers



Haubold PN 1416
Item No. 12954



Fasco F1B 14-16
Item No. 12952

Type	Length	Finish	Quantity/Box	Boxes/Carton	Item No.
1404	1/8"	Galvanized	10,000	20	13058
1405	3/16"	Galvanized	10,000	10	13059
1406	1/4"	Galvanized	10,000	20	13070
1408	5/16"	Galvanized	10,000	20	13071
1410	3/8"	Galvanized	10,000	20	13072
1412	1/2"	Galvanized	10,000	20	13073
1414	9/16"	Galvanized	10,000	10	13069

1410 / SP 3023 Stainless Steel Staples

Type	Length	Quantity/Box	Boxes/Carton	Item No.
SS1410	3/8"	10,000	10	13046

Narrow Crown Galvanized Staples to fit Haubold Tackers

Type	Length	Quantity/Box	Boxes/Carton	Item No.
1010 (3412)	3/8"	5,000	20	13140
1012 (3416)	1/2"	10,000	20	13142
1014 (3418)	9/16"	10,000	20	13144

Type	Length	Quantity/Box	Boxes/Carton	Item No.
4010	3/8"	10,000	10	13107
4012	1/2"	10,000	10	13109

Staples to fit: Haubold PN 1812G, Duofast 3012, BeA No. 72, Rainco 6416.

Type	Length	Quantity/Box	Boxes/Carton	Item No.
Economy 1806	1/4"	10,000	20	13185
Economy 1808	5/16"	10,000	16	13191
Economy 1810	3/8"	10,000	20	13189
Economy 1812	1/2"	10,000	20	13190

Staples to fit: Haubold PN 814G - Galvanized

Type	Length	Quantity/Box	Boxes/Carton	Item No.
806	1/4"	20,000	30	13167
808	5/16"	10,000	24	13166
810	3/8"	10,000	18	13168
812	1/2"	10,000	16	13169

STAPLES



DuoFast #EI 3118
Item No. 12930

Staples to fit Duo-Fast EI 3118 Electric Tacker (New Model)

Type	Length	Quantity/Box	Boxes/Carton	Item No.
ED 3108	1/4"	10,000	20	13047
ED 3112	3/8"	10,000	20	13151
ED 3116	1/2"	10,000	20	13154

Intermediate Crown GALVANIZED Staples to fit Duo-Fast EI 33 Series Electric Tacker (Old Model)

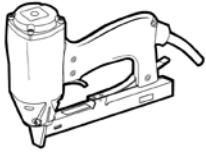

Type	Length	Quantity/Box	Boxes/Carton	Item No.
3308	1/4"	10,000	20	13160
3310	5/16"	10,000	20	13162
3312	3/8"	10,000	20	13164
3318	9/16"	10,000	20	13165

DuoFast CT 5000
Hand Tacker
Item No. 12942

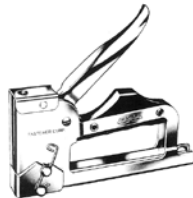

Staples to fit the DUOFAST CT 5000 Hand Tacker

5012 Stainless Steel Staples

Type	Length	Quantity/Box	Boxes/Carton	Item No.
SS5012	3/8"	5,000	20	13048



5012 Wide Crown Galvanized Staples

Type	Length	Quantity/Box	Boxes/Carton	Item No.
5012	3/8"	5,000	20	13174
5018	9/16"	5,000	20	13125



Narrow Crown GALVANIZED Staples

Type	Length	Quantity/Box	Boxes/Carton	Item No.
5412	3/8"	5,000	20	13194
5416	1/2"	5,000	20	13193

Blued Upholsterers Tacks (Cut Tacks) Shoe Tacks

Ounce No.	3	4	6	8	10	12	14
Length	3/8"	7/16"	1/2"	9/16"	5/8"	11/16"	3/4"
One lb. box	13304	13306	13308	13310	13312	13314	13316
25 lb. carton	13382	13384	13386	13388	13390	13392	13394



**No-Sag
Ardox Spiral Nails**
sold by the pound
Item No. 12790

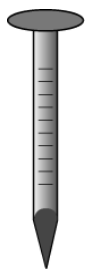

Blued Wire Tacks

- for securing webbing

Ounce No.	10	12	14
Length	5/8"	11/16"	3/4"
One lb. box	13324	13326	13328
25 lb. carton	13398	13400	13402

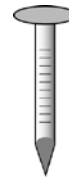

13 Gauge Zinc Plated Wire Spring-Up Nails

13 gauge, 7/8" large head nail

1 pound Item No. 13331
50 pound carton Item No. 13405

Robertson Stainless Steel Wood Screws



Description	Finish	Qty	Item No.
Fastener 852 1/2"	-	-	11096
#8 x 3/4" Rob Flat	SS	100 / Box	12490
#8 x 1" Rob Flat	SS	100 / Box	12492
#8 x 1 1/2" Rob Flat	SS	100 / Box	12494
#10 x 3/4" Rob Flat	SS	100 / Box	12496
#10 x 1" Rob Flat	SS	100 / Box	12498
#10 x 1 1/2" Rob Flat	SS	100 / Box	12500



Nail Beading

10 yard econo rolls for smaller projects

Pewter + nails Item No. 12219

Fr. Natural + nails Item No. 12220

Designer Nails for Leather Furniture

Style	Finish	Diameter	Qty / Box	Item No.
1507	Old Brass	14 mm	250	12286
1052	Old Brass	21 mm	250	12288
1037	Light Oxidized	20 mm	250	12283
1037	Bronze Ren	20 mm	250	12284
1037	Old Brass	20 mm	250	12285
1054	Bronze Ren	16 mm	250	12258
Additional Shading				
1009	Old Brass	11 mm	1 000	12243
1009	French Natural "ST"	11 mm	1 000	12271
1009	French Natural #5	11 mm	1 000	12245

DECORATIVE NAILS

Domed Head No. 9 (11 mm dia.) Furniture Nails 1,000/Box

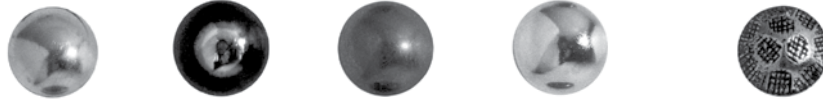

Name of Nail and Finish	Bright Brass	Antique Brass on Steel		French Natural	Nickel Plated		Oxford (Hammered Brass)	
Shank	1/2"	1/2"	5/8"	1/2"	1/2"	3/4"	1/2"	3/4"
Item No.	12248	12250	12251	12246	12254	12256	12240	12242



Nail Beading Styles

50 yard coils nail blank every 5 nails

Beading Style	Order	Nails
French Natural	12290	12245
#1 Pewter	12297	12266
Nickel Beading	12291	12293

Nickel Plated Beading Item No. 12291

Nickel Nails to match (750 / box) Item No. 12293

No. 265 Coloured Metaline Nails

Flat Black	Item No. 12272
Medium Brown	Item No. 12262
Red	Item No. 12260
White	Item No. 12274

- 4 colour choices of metaline leather look nails
- 7/16" dia.
- 1/2" shank
- 1,000/box

NO. 52 PLATED NAIL

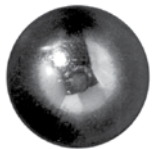

- 3/4" dia. head
- 5/8" shank
- sold individually or 500 to a box

Bright Brass Nickel Plated

Item No. 12280 Item No. 12282

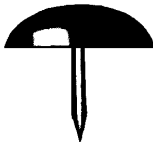

depicted actual size

Don't forget to ask for your nailboard!

Decorative Upholstery Nails from Triden Distributors Limited
Note: See Back Panel for Nail Specifications

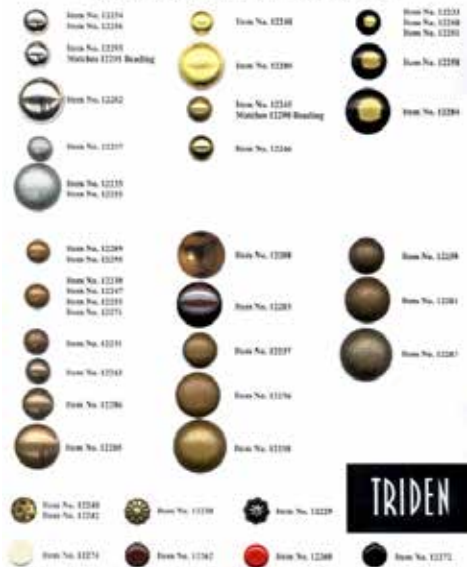

Decorative Nail

Bulk Feed Nail Gun

- holds 90 single nails (sizes 9 or 1009)
- up to 125psi ensures centered and properly spaced nail head look with consistent application
- remove from air flow when not in use

Item No 14097

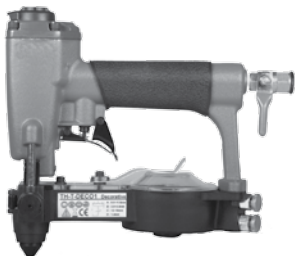



T-Nuts

Dimension quoted is diameter of threaded hole packaged in 100's



Prong Type

1/4" - prong Item No. 13196
5/16" - prong Item No. 13198

Metric Prong Type

8 mm Item No. 13195

Plain Type

1/4" - plain Item No. 13199
5/16" - plain Item No. 13197

Hanger Bolts

5/16" x 3 1/2" Item No. 11870
1/4" x 3 1/2" Item No. 11871

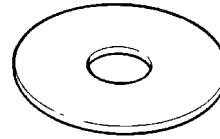

Plastic Leg Hole Finders

1,000s Item No. 12124



Panel Nails

- use on facings to nail upholstered panels to frames.
- 3/4" diameter
- sold by the pound



Threaded Panel Nails

1 1/8" shank Item No. 12301

Plain Panel Nails

7/8" shank Item No. 12300

Screw Hole Plugs

- packaged in 100's
- mushroom type
- made of birch
- 3/8"

Item No. 12550



Screw Cap Covers

- 2 part system hides screw heads
- just screw bottom piece in, then snap on the cover
- 100 / pack

Black Item No. 12502

White Item No. 12504

TACKING STRIP

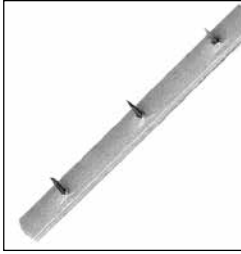

Heavy Steel with 9oz Nail “The Good One”

- sold each in bundles of 25

Item No. 13250 - 24"

Item No. 13254 - 30"



Trim Tack Strip

- thin steel
- punched out tack
- serrated edge for a stronger hold

Length 24" 27" 30"

Item No. 13274 13278 13282

All the above types of strip are available in any length not listed in full (500 pieces) cartons as a Special Order. Any size listed above is sold either in bundles of 25 or in full cartons.



Economy Tackite Tacking Strip

- 8 oz. tack
- thin steel, punched out tack
- sold by the case only
- serrated edge for a stronger hold
- 500 pieces per case

Length	3"	8"	14"	15"	16"	17"	18"	21"
Item No.	16743	16748	16754	16755	16756	16757	16758	16761
Length	22"	23"	24"	26"	27"	28"	30"	36"
Item No.	16762	16763	16764	16766	16767	16768	16770	16776

Protective Coverings for Tacking Strip

1. (illustrated) **Perma Stick**
2. **Extruded Plastic Sleeve**

protective foam strip

3/4" - 75 foot rolls

Item No. 13291

slides over tacking strip

2 styles - both put up in

1,000' centre pull cartons

Large

for Steel Tacking Strip

Item No. 13292

Small

for Trim Tack

Item No. 13294



Flex-trim

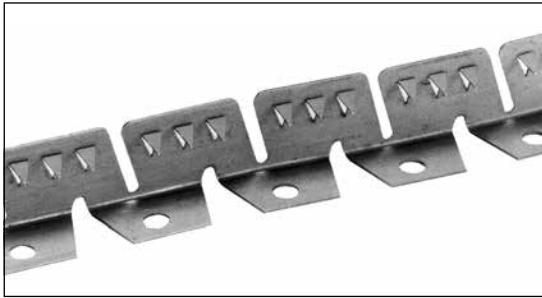

Also called "Pli-Grip"

- a flexible tacking strip for both inside and outside curves
- attach fabric to metal prongs, hammer into place
- eliminates hand sewing
- 100' coils
- 3 tooth

Regular Item No. 13216

Medium Item No. 13219

Medium 3 Tooth / Leather Item No. 13220

Heavy Item No. 13218

CARDBOARD

"S" Cardboard Tacking Strip

- 375' rolls
- 1/2" x .040

Item No. 13200

- 40 pound bulk carton
- 1/2" x .030

Item No. 13201

Chipboard

- 31" x 41" x 45pt
- sold by the sheet
- first quality, not recycled
- attractive medium brown colour, one side

Item no. 10480

Hardflex Blind Tacking Strip

- crushed fibre board
- 1/2" wide by .050
- 15" dia. coil
- 6.5 pounds per coil

Item No. 13205

Millboard

- 32" x 38" x .080 (3/32")
- by the single sheet or bundles of 25

Item No. 10484

Tacking Strip - Cut Pieces

- convenient 36" lengths
- 50 lb. cartons or 5 pound bundles
- 2 thicknesses to choose from

.050 Item No. 13206 "Premium Cut"

.060 Item No. 13210

THREAD



“High Spec” CSB-69 Nylon Thread

- bonded and lubed 3 ply
- 11 lb. tensile strength
- colourfast
- 3,000 yard (8 ounce) spools
- abrasion and wear resistant
- high strength
- left twist

No.	Colour	Item No.	No.	Colour	Item No.	No.	Colour	Item No.	No.	Colour	Item No.
721Q	White	13750	744Q	Black	13751	745Q	Beaver	13752	751Q	Beige	13753
775Q	Bluebell	13754	756Q	Brown	13755	758Q	Dark Brown	13756	763Q	Light Brown	13757
767Q	Caramel	13758	783Q	Carafe Green	13759	785Q	Charcoal	13760	788Q	Dark Claret	13761
786Q	Cream	13762	796Q	Med.Graphite	13763	779Q	Dark Green	13764	777Q	Dark Gray	13765
776Q	Light Gray	13766	781Q	Dark Jade	13767	770Q	Leaf	13768	790Q	Marine	13769
722Q	Natural	13770	765Q	Navy	13771	771Q	Omni Blue	13772	795Q	Opal	13773
757Q	Red	13774	774Q	Rose	13775	793Q	Saddle	13776	766Q	Scarlet	13777
792Q	Silver	13778	772Q	Slate	13779	752Q	Taupe	13780	782Q	Teal Blue	13781
753Q	Toboggan	13782	797Q	Dark Willow	13783	787Q	Wine	13784	764Q	Yale Blue	13785



Tunnel Tie

Tunnel Tie is used on padded and upholstered stools, chairs as well as the automotive industry and makes installation of upholstered fabric easier.

Sew Tunnel Tie to fabric, skin over foam bun, and then pull cord to tighten. Staple cord to close.

Seat build processes become more efficient and cost effective by:

- Minimizing ergonomic injuries
- Reducing labour costs
- Reducing raw materials

The advantages of Tunnel Tie drawstrings are:

- Improved, integrated recyclables with other trim components
- Improved wrinkle reduction of assembled trim covers
- Eliminates rattle and squeak sounds
- Efficient on leather, vinyls and cloth

Item No. 11110

Perma Spun Polyester Machine Sewing Thread

- High tenacity, low shrinkage.
- Knot free for superior sewability.
- Excellent colorfastness.
- For all apparel, home furnishings and bedding.
- Available in sizes Tex 27 through to Tex 120.
- 25 colours
- Available in 5,000, 10,000 and 20,000 meter put-ups.

Monofilament Transparent Thread

- eliminates the need to stock a wide colour range in the shop
- available in 3 strengths, either canister or plain
- sold by the pound
- spools approximately 1 1/2 lbs.

Size	40	52 Popular One	63
With Cannister	13600	13604	13608
Application	Quilting	General	Vinyls
Yield per Pound	10,650 yds./lb.	8,500 yds./lb.	8,500 yds./lb.

ASTRA Serging Thread



Over 20 Spectrum colours to choose from!

- No. 70 Serging Thread
- 100% Polyester
- White
- 24,000 yard spools
- 6000 metre spools

Item No. 13651

CSB 207 Hand Sewing Thread



- 16 oz. spools
- superior quality
- resists curling

Black - Item No. 13701

White - Item No. 13703



THREAD - OUTDOOR

“Sunguard” UVR Bonded Polyester Thread

- Size CSB 92 • U.V. Resistant • Anti-Wick • 8 ounce spools
- Colours match Coastguard and Top Gun Marine Toppings
 - recommended for Acrylic/Polyester applications only
 - colourfast dyes prevent fading

205 Bay Brown 45338	204 Beige 45300	209 Black Cherry 45304	213 Blue Wave 45342
208 Burgundy 45306	207 Cardinal 45308	223 Charcoal 45310	217 Dark Teal 45312
215 Dusk Blue 45314	220 Forest Green 45316	236 Graphite 45344	234 Med. Titanium 45317
216 Navy 45318	218 Ocean Green 45320	202 Oyster 45322	214 Pacific Blue 45324
226 Plum 45326	231 Saddle 45328	203 Sand 45330	219 Shamrock 45340
222 Shark Gray 45332	212 Sunflower 45346	227 Taupe 45334	

Black and **White** Sunguard are also available in both 8 oz. and 16 oz. spools:

	8 ounce spools	16 ounce spools
Black	Item No. 45302	Item No. 45303
White	Item No. 45336	Item No. 45337

“Premofast” Polyester Thread

- for outdoor sewing applications
- White and Black shipped in 16 oz. spools
- Colours shipped in 8 oz. spools • size 92

231	Forest Green	45620
241	Mint Julip	45630
236	Persian Green	45647
Black		45605
White		45600

“Sew-Awn” UVR Bonded Awning Polyester Thread

Sew-Awn thread is a heavy-duty (B138) version of Sunguard. It is, of course, U.V. Resistant, Anti-Wick and Colourfast, and ready to take on sewing applications that require a more durable thread.

- Colours match Coastguard and Top Gun Marine Toppings.
 - put up on 16 ounce spools

Colour	Item #	Colour	Item #	Colour	Item #
205 Bay Brown	45311	208 Burgundy	45339	214 Pacific Blue	45301
3187 Beaver	45345	207 Cardinal	45313	203 Sand	45321
204 Beige	45341	220 Forest Green	45307	222 Shark Grey	45309
224 Black	45343	216 Navy	45305	201 White	45349

No. 6 Polyester Tuff Twine®

- tensile strength of approx. 365 lbs.
- yield of 366 feet per pound

Five Pound Tube Item No. 15312

Ten Pound Ball Item No. 15311



#1 & #2 - No. 6 Tuff Twine 1 lb. & 5 lb. sizes;

#3 & #4 - Syntwine 1 lb. & 10 lb.

Syntwine

- 100% polyester soft spring twine
- eliminates squeaking
- rot proof and flame retardant

Ten Pound Spool Item No. 15318

Stitching Twine Linen Twine

- convenient dispenser box
- 250 gm. size

No. 4 Item No. 15332



Barbour's Stitching Twine

Button Tufting Twine Supertwist

- 1" core
- 100% nylon
- 80 lb. breaking strength
- 2,200 feet per pound

One Pound Item No. 15346

Two Pound Item No. 15348



Sewing Machine Oil

1 Ltr Item No. 13035



Air Tool Oil

A drop a week in the air inlet

Item No. 13036

T Pins

- 1/2 lb box
- 2" steel

Item No. 12427

CHALK



School Chalk

- dustless
- 1 gross per box

Item No. 10700 - White

Item No. 10702 - "Sight Saver" Yellow

Tailor's Chalk

- 48 wedges per box

White Item No. 10704

Yellow Item No. 10706

Black Item No. 10708

Red Item No. 10710

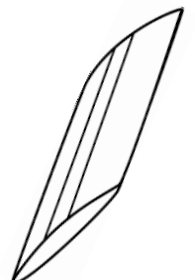

China Marker Pencils

- 12 per box
- White
- indelible - will not wash off fabric

Item No. 10711

Clay Tailor's Chalk

White COL 268

CONVERTIBLE TOPS

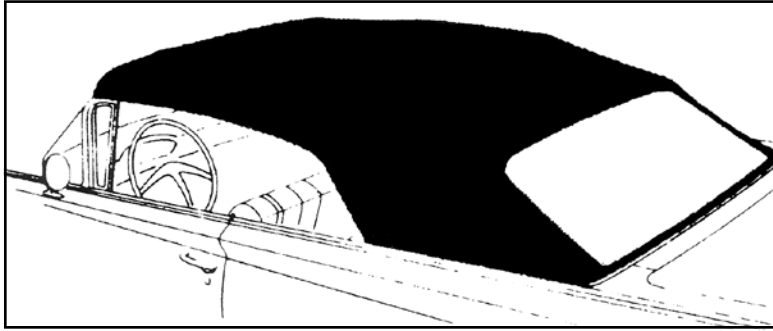

*We stock a wide range of Convertible Tops and hard glass windows.
Request your Convertible Top Catalogue and colour swatch card.*

ACCESSORIES

Vu-Flex (AS-6 Regalite)

plastic rear window curtain replacement
double polished clear
.040 ga. thickness

24" x 54" **Item No. 15480**

29" x 62" **Item No. 15484**

29" x 68" **Item No. 15483**

54" x 110" **Item No. 15487**

New! .040 ga. in CHARCOAL

29" x 68" **Item No. 15481**

New! .040 ga. in Green Tint!

24" x 54" **Item No. 15485**

Also available: .030 ga. Clear

54" x 110" **Item No. 15486**

Also in .030 ga. SMOKE (Tinted)

54" x 110" **Item No. 12632**



Tack Band

tack strip for rear bow
made of hard extruded plastic
2 sizes, sold by the foot

Rear

Front

1/2" x 3/8"

5/8" x 1/8"

Item No. 14730

Item No. 14732



Convertible Top Frame Webbing

Black

9" width (standard for Camaro/Corvette)

sold by the yard

Item No. 15579

Universal Pads

Black

Sold by the pair

Item No. 14720



Stainless Steel Welt Tips # 7185

• for wire-on binding

Item No. 10167

HAARTZ Convertible Topping Material

sold by the yard heavy duty single texture vinyl coated, 54" wide

Foreign (Colonial Grain)

Black on Black **Item No. 15154**

Domestic Pinpoint Grain

Black on Black **Item No. 15150**

White on Black **Item No. 15152**

Note: Colours available to Special Order.

Stayfast

laminated acrylic • 60" width **WILL NOT FADE!**

Stock Colours: • Black on Black - **Item No. 15165** • Tan on Tan - **Item No. 15164**

Stayfast is also available in the following colours:

- Blue/Tan • Black/Tan • Burgundy/Beige • Charcoal/Black • Chocolate Brown/Beige
- Dark Ruby/Black • Driftwood/Black • Gray/Black • Navy Blue/Beige • Neutral/Black

Call our Order Desk for more Details

Bias Binding for Stayfast

- 1.25" width - one edge turned

Black **Item No. 10090**

Tan **Item No. 10092**

Wire-On Binding for Stayfast

Black **Item No. 10094**

Tan **Item No. 10096**



Aplix Brand Fastening System

hook and loop for outside applications
special pressure sensitive formulation is ideal for tonneau covers
cuts or 50 yard rolls

Pressure Sensitive 1" Black Hook **Item No. 15390**

Pressure Sensitive 2" Black Hook **Item No. 15392**

Regular Backed 1 1/2" Black Loop **Item No. 15394**

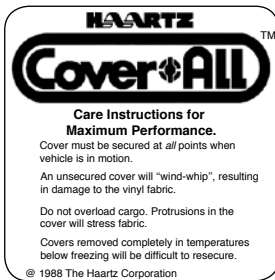

"Coverall" Tonneau Material

78" wide vinyl coated
elk grain

Black **Item No. 15204**

Garnet (Burgundy) **Item No. 15205**

Slate Gray **Item No. 15207**

Cream White **Item No. 15203**

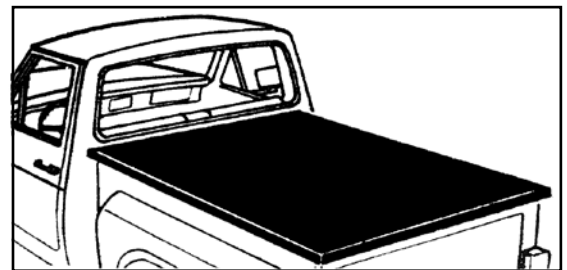

Tonneau Wooden Bows

• 72" wide **Item No. 15212**

Temporarily Out of Stock

This informative Sew Tag is supplied with every cut you order

**Use Bow Sockets (page 53) to support tonneaus.
Aplix (above) or Fasteners (pages 14-16) to secure tonneaus.**

Black Cobra Decking

for soft roof replacement material on antique cars

54" wide, **Short Grain**

Item No. 15501

Visit triden.com or call 905.421.2955

Landau Padding

- Closed cell construction
- 60" wide
- sold by the yard

1/8" thick - white	Item No. 15230
1/8" thick - black	Item No. 15231
1/4" thick - white	Item No. 15232

Detroit Body Cloth Book

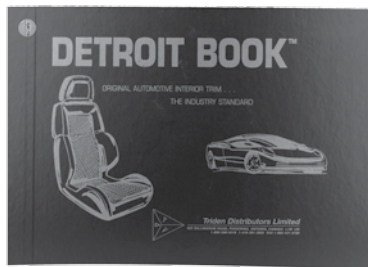

Order Your Current Model Year

Cements



DAP 233 Contact Trim Cement		Item No. 10625
CP 2056 Fast Tack Trim Cement	950 ml	Item No. 10652
"4510" Landau Cement	13.25 L pail	Item No. 10661
	3.78 L Can	Item No. 10662
Fast Tack 92 Aerosol Adhesive	13 oz	Item No. 10650



*See our Complete Cements Section on pages 6 - 7
Solvents for Clean-Up are on Page 7*

Automotive Replacement Carpet - by Dorsett

Detroit	Loop Pile	40" wide
Eldorado	Cut Pile	40" wide

We stock a wide assortment of colours of both types of Automotive Carpet

We also carry 96" wide Marine and Van carpet.

Sample cards for these carpets are available upon request.

Carpet Underlay

non-woven needle punched
36" wide FR mildew resistant
27 oz. **Item No. 10464**
40 oz. **Item No. 10463**

Listing Tape

• White • Folded • 1" wide
100 yard rolls
Item No. 10166

Trunk Lining

9 oz. 54" wide
Charcoal / Black **Item No. 15220**
Gray **Item No. 15222**
Black **Item No. 15221**

Plastic Foot Switch

Item No. 10461



Heel Pads

• 9 1/4" x 17 1/2" • heavy duty vinyl

Brown	Item No. 10468	Green	Item No. 10472
Black	Item No. 10469	Light Blue	Item No. 10477
Caramel	Item No. 10470	Maroon	Item No. 10474
Dark Blue	Item No. 10478	Red	Item No. 10471
		Saddle	Item No. 10476

“Top Line” Vinyl Bias Binding

See Page 81 for
Stayfast
Wire-on and
One Edge turned
Bias Binding

- 1 1/4" wide, 1 edge turned
- for binding convertible tops

Colour	Repp Grain	Colonial Grain
White	Item No. 10102	Item No. 10112
Black	Item No. 10100	Item No. 10110

Other Colours are available - Call the Order Desk for details.

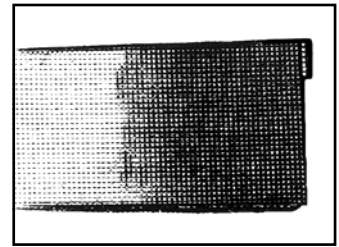

Hydem Binding - 50 yard spools

Metallic Finish		Solid Colours			
Gold	10182	Black	10184	Beige	10183
Silver	10180	Gray	10185	White	10186
Black (300 yard spool) Item No. 10195					

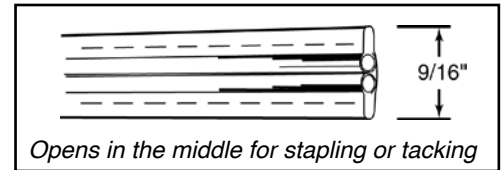

Carpet Binding

Use #300 Bias Binding. Refer to page 54 to choose from 16 different colours.

Wire-On Binding

Colour	Repp Grain	Colonial Grain
White	Item No. 10157	Item No. 10165
Black	Item No. 10155	Item No. 10163

Stainless Steel Welt Tips # 7185 Item No. 10167

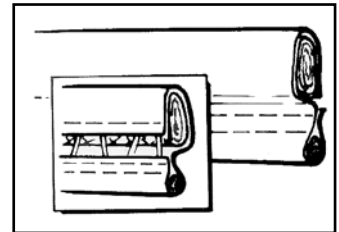

Extruded Embossed Vinyl Welt

- 100 yard spools
- slashed for ease of sewing

Black	Item No. 15584	Dark Gray	Item No. 15590	Navy	Item No. 15585
Bone	Item No. 15580	Dark Green	Item No. 15589	Off White	Item No. 15581
Brown	Item No. 15587	Gray	Item No. 15583	Red(Firethorn)	Item No. 15582
Buckskin	Item No. 15591	Medium Blue	Item No. 15592	Tan	Item No. 15586
		Medium Brown	Item No. 15588		

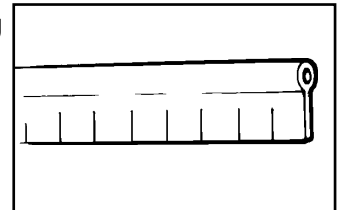

Specialty Trim

1. Windlace

- 1/2" foam core
- 5/8" sewing flap
- sold by the yard or 50 yard carton
- Black Item No. 15575
- Antique Gray Item No. 15574

2. 1/2" Sponge Core - Kraft Rod

- with 1/2" heavy kraft paper sewing flap
- sold by the yard or 50 yard carton Item No. 15578

3. 1/2" Sponge Core - Plain

- sold by the yard or 50 yard carton Item No. 15576

4. Black Compact “Snap On” Windcord

- 100 foot rolls
- Item No. 15573 - Black
- Item No. 15571 - White

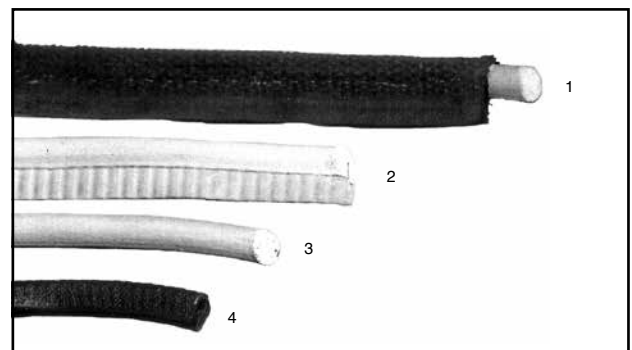

Anchor Clips for Snap-On Windcord
100 per box Item No. 12548

AUTO TRIM TOOLS

"The Easiest Tool to Use That We Sell !!!

Press-N-Snap Setting Tool

- sets Snap fasteners
 - comes complete with necessary dies
- Item No. 14260**









Replacement Parts for Press-N-Snap

- | | |
|----------------|-----------------------|
| Lever | Item No. 14246 |
| Spring | Item No. 14247 |
| Bolt & Nut Set | Item No. 14248 |
| "C" Clamp | Item No. 14260 |
| Handle | Item No. 14261 |
| Plunger | Item No. 14267 |
| Small "O" Ring | Item No. 14268 |
| Stud "O" Ring | Item No. 14269 |

Press-N-Snap Grommet Dies

- | | |
|-------------------|-----------------------|
| Sets # 0 grommets | Item No. 14278 |
| Sets # 1 grommets | Item No. 14279 |
| Sets # 2 grommets | Item No. 14249 |

Replacement Dies for Press-N-Snap		
 Button Die (X2 10128) Item No.14262	 Eyelet Die (BS-10412) Item No. 14265	 Rubber Ring (M2700) Item No. 14266
 Socket Die (XB-10224) Item No.14263	 Stud Die (BS-10370) Item No. 14264	 Pull-the-Dot Socket Die Item No. 14257

Dies for Baby D.D. Fasteners	Item No. 14256
Die for Gypsy Stud	Item No. 14271

Optional Dies available: Hole Punch, Lift the Dot, Pull the Dot.

Call our Order Desk for more details.

HAND SETTING TOOLS



Cutting Punches

- C4 Common Sense
Item No. 14230
- L6 Lift the Dot
Item No. 14234



No. 160 Button Die
for 670 button
Item No.14220



No. 160 Eyelet Die
for 550A eyelet
Item No. 14222



No. 164 Setting Punch
for snap fasteners
Item No. 14224

Snap Fastener Pliers

- sets all 4 parts of snap fasteners
- Item No.14253**



Grip Fast Setting Die Kit
complete with 4 metal dies which snap onto vice grips.

- Item No. 14270**
Vice Grips
- Petersen T3-10S
Item No. 14272

OTHER POPULAR TRIMMER'S TOOLS



Tucking Tool

- for installing headlining



Item No. 13813

No. 1020 Auto Trimmer's Knife
beechwood handle for seam ripping, cut carpet, vinyl etc.
Item No. 13878

Razor Blades

- Safety one side
 - 100/pack
- Item No. 14010**

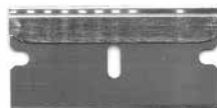

Master HG-501A-D

Heat Gun

- 12 amp. 120 VAC.
- produces from 500°F to 750°F of heat to make any job easier
- adjustable non-slip stand
- 1500 watts of power

Item No. 14049

FASTENING HARDWARE



Air Hog Ring Power Tool

Air powered hog ring tool shoots mag loads of hog rings.

Item No. 13038

"D" Point 3/4" Hog Rings

Magazine load for air-powered gun pictured above

Item No. 11884 - 10,000 per carton

Also available "C" Style magazine loads

Item No. 11885 - 1000/carton



3/4" Hog Rings

- loose by the pound

Item No. 11880

Stainless Steel Washers

Ref. #	Type	Size	Item No.
614	Countersunk	6	12538
616	Countersunk	8	12540
618	Countersunk	10	12541



Pop Rivets

- 1/8" aluminum rivet - AD45ABS

Item No. 12480 - 500/box

- 1/8" stainless steel rivet - SSD45SSBS

Item No. 12479 - 1,000/box



Door Panel Clips

- brown
- No. 1202

Item No. 10834 - 25 per box



Trim Panel Fastener 808

- no head (blind) General Purpose for any trim application
- No. 808

Item No. 10835 - 24 per box

Hog Ring Pliers

No. 1440 B Open Spring (shown)

Item No. 13830

No. 1440 A - Straight

Item No. 13826 - (open spring)

No. 1440 B No Spring

Item No. 13827 - (angled 135°)

Close Spring Straight

Item No. 13834



Auto Top Zippers by YKK®



Jeep Zipper

- Black #10 Coil Zipper exclusively for Jeep soft tops
- 96" open-end zipper, 1" tape
- tab slider on one side, pull-ring slider on other

Item No. 16117 (shown)

Tracker / Suzuki Zipper

- #10 Coil Zipper exclusively for Tracker / Suzuki soft tops
- 74" open-end zipper, 1" tape
- tab slider on one side, pull-ring slider on other

Item No. 16098 - Black 74"

Item No. 16097 - White 74"

2 Way Jeep Zipper

- Black #10 Coil Zipper, 96" long
- 1 double tab slider on each end

Item No. 16118

Christmas Tree Plugs

100 / Package

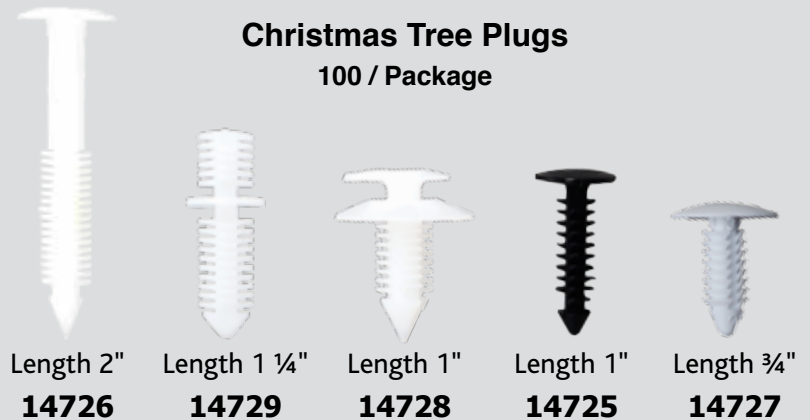

"S" Hooks



- sold by the pound
- 400/lb.

Item No. 11888

Panel Board - Large

- use in cowl or rear shelf
- 39" x 65" x .070
- black embossed
- lacquered one side
- 25 sheets/case

Item No. 10370

Door Panel Board - Small

- waterproof
 - coated both sides
 - 32" x 48" x .100
- Item No. 10372

Rebond Chip Foam

22" x 72"

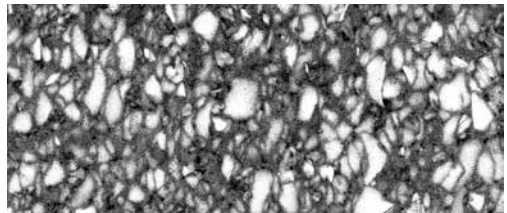

- 1" Item No. 11496
- 2" Item No. 11494
- 3" Item No. 11492
- 4" Item No. 11490

Scrimback Foam

excellent for sewing
Flame Retardant

- 1/2" x 56" Item No. 11450
- 1/4" x 59" Item No. 11452

"High Spec" CSB-69 Nylon Thread

8 ounce (3,000 yards) per spool
White Item No .13750
Black Item No. 13751

Over 30 colours - Check Page 76
or **call for Details.**

Seat Belt Webbing

- 2" nylon
 - 100 yard rolls
 - sold by the yard
- Black Item No. 15650
White Item No. 15652
Red Item No. COL148

Shock Cord and Clips

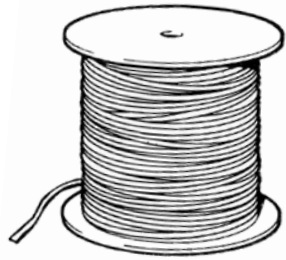

Shock Cord (nylon covered)

- 3/16" dia. 100' roll Item No. 12615
- 3/16" dia. 500' roll Item No. 12616
- 1/4" dia. 500' roll Item No. 12618
- 3/8" dia. 150' roll Item No. 12620



Black Lexan for 1/4" diameter cord.
Hook and collar to fit over cord end.
Item No. 42735

Nylon coated metal hook to hold 1/4" shock cord.
Item No. 42733



Adjustable. Rustproof hook adjusts
in seconds and fits 3/16" or 1/4" cord.
Item No. 42734

Adjustable snap-hook type
fits 3/8" shock cord.
Item No. 42732

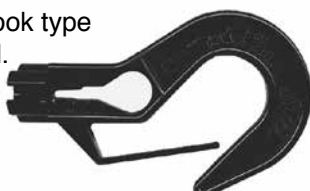

Quilted Vinyls

for vans and winterfronts

For your convenience, we stock our GAUCHO FR vinyl in Pattern No. 1, in the following colours:

Black	Blue	Chestnut	Desert Sand	White	Wine
31000	31002	31004	31006	31008	31010

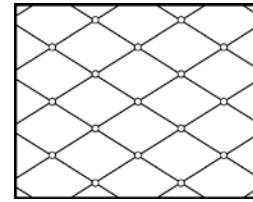

Custom Quilting of all our vinyls is also available - call the Order Desk for details. 1540 minimum - Call

Pattern No. 1

4 1/2" diamond with button

Transportation Rated Vinyls

Truckleather - MVSS 302 FR

Bus Vinyl - O.E.M. School Bus

- Colours - Brown, black and green

Ask for Sample Card

“Kartex” Napped Car Cover Cloth

- to protect show cars
- 56" width
- not for outdoor applications

Suntan Item No. 41575

Solution Dyed Acrylic Black 24

7/8" wide very soft and strong, Use for sewing support, French seams, under vinyl, leather or fabric seating to make a better bind. Flexible so will follow curves easily.

- 164 yards on a card
- other colours available
- great for scalloped edge

Item 70301

Seat Clip Vinyl Extrusions

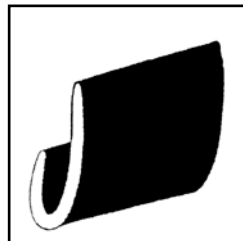

Flexible Channel
1/2" lip x 7/8" flange
• opening is 1/16"
cuts or 100' rolls

Black Item No. 11007

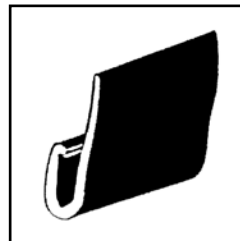

Semi-Rigid Channel
3/8" lip x 1 1/4" flange
• opening is 3/16"
54" strip

Black Item No. 11008

Auto Seat Heater

- install under cover
- easily installed
- a great add on feature

Item No. 15167

INDEX

A					
Accord bottom lining	37	Cotton glazed thread	79	Grip Fast setting dies for fasteners	86
acrylic binding	56	Cotton pocket unit	62	grommets	18
adhesives	6 - 8	coupler plugs, for air hose	49	grommet setting tools	18, 53
air compressor	50	Curon foam	31	guide, foam cutter	51
air pressure gauge	50	curved needles	45		
airline accessories	49	cushion stuffing machine	52	H	
air regulator	50	cushion wrap, polyester	35	hand sewing thread	79
aluminum ruler	43	cutters, foam	51	hand tackers	48
anchor edge roll	61	cutting machine, for buttons	47	hand tools	40 - 44
Aqua-Tite Top Gun Sealer	9	Cyrex synthetic cheese cloth	37	Handy automatic button machines	47
arch punch	43			hanger bolts	29
automatic awl	43	D		hammer handles	40
auto tops	82	D ring	18	hammers	40
		Dacron Hollofil	35	hardflex tacking strip	77
B		Dacron throw cushions	33	hardware, marine	54 - 59
backer rod - foam welting	60	dead blow hammer	53	Haubold staples	71
bags - sofa or chair	69	decking	36 - 38	headlining	84
ball casters	22, 24	decorative nails	74	heat gun	86
bare spring cushion unit	62	Delrin zipper	21	heel pads	84
Bazooka air blower	44	dies, setting, buttons	46	helical springs	65
bean bag chair filler	35	dies, setting, fasteners	86	hessian	39
belt punch	53	dies, setting, grommets	53	high density foam - Curon	31
binding - Bias	56	dimmer switch grommet	84	hinge link - No-Sag	65
- Hydem	85	display felt	36	hinges - boat seat type	58
- Wire-on	85	door panel clips	87	hog ring pliers	42
blades, foam cutter	51	door panel boards	88	hole cutters	53
blades, Olfa knife	42	dome fasteners	15	Hollofil Dacron 91	35
blind tacking strip	77	double tab sliders	20	hollow tufting needle	43
blow gun, safety type	49	down and feather fill	34	hose clamps, air line accessories	49
blown fibre	35	Duo-Fast tackers - air, electric, hand	48	hospital vinyl - ticking	39
boat seat hinges	58	Duralux foam	30	- sheeting (Lectrolite)	39
boat top frame kit	54	Dura-Snap buttons	14	hydem binding	85
bolsters, foam, round	33			I	
bolsters, foam, wedge	33	E		ILD - indentation load deflection	31
border tube (for edge wire)	67	edge roll	61	insulators - deck pad	39
bow socket	55	edge wire and accessories	67		
bottom stops	20	EK,EKS clips	65	J	
brad nailer, brads	48	elastic	16, 68	jaw slide	55
brass ventilators	18	elastic webbing	68	Jet-Spray lacquer	11
buckles - boat tops	55	electric tacker	48	Jiffy steamers	52
bun legs	29	extruded vinyl welt (plain or embossed)	56, 85	Jute - edge	61
burlap (Hessian)	39	eye snaps and rings	18	- webbing	68
button dies	46	EZE cushion filler	52		
button machines, Handy	47			K	
buttons - shells	12	F		Kevlar Fireblocker	37
- backs and prongs	13	fabric treatment	10	Klinch-It fasteners	44
BW clips	67	fasteners	15-19	Klinch-It tool	44
		feather and down mixture	34	knife, auto trimmer	42
C		Featherspray foam cement	7	knobby twist pins	18
C clips	67	felt, upholstery	34	knotted coil springs	66
cardboard	77	fibreluft	35		
carpet underlay	84	fibre tacking strip	76	L	
carpet cement	8	fishmouth springs	66	lace (shoe) tack	73
carpet, automotive	84	Flexcon	67	lacquers, Jet spray	11
caster fittings	23	Flextrim	77	Landau cement	8
casters	22 - 24	foam and fillers	30 - 35	Landau padding	84
chair bases, swival rocker	63	foam adhesive	6	leather cleaner	9
chalk, school or tailors	81	foam cutter, electric	51	leather punch, revolving	42
chevron hair	34	foam cutter bit for tufting	43	leg hole finders	29
chip foam	34	foam rolls - poly	32	legs, furniture	29
cleaners	9	foam slicer - U-cut tool	44	leveller glide	28
clips, EK,EKS,G	65	Fortrel	35	Lift-the-Dot fasteners	17
clips for Snap On Windcord	85	frame edging	61	links, connecting and hinge	65
closed end zippers complete	20	frames - boat tops	54	linings	36, 37
coil springs	66	fusible lining - Pellon	38		
Comfor-dry mattress ticking	39	futon hinge	62	M	
Comforel synthetic fibre	34			machines, button	47
common sense fasteners	16	G		mattress - foam	30-32
compact windcord	85	G clips	65	mattress - spring for sofa bed	62
compressors, air, related	48 - 50	gimp	69	metaline leather look nails	74
connecting links	65	glides	28	metric conversion tables	4
contact cement	6 - 8	glossary	4	millboard	77
convertible tops & topping	82, 83	glue gun, hot melt	51	monofilament thread	79
Cotton lining	36	glue gun, spray type	50		
		glue sticks	51		

N		R		T	
nail beading	74	Rainco/Fasco tackers	48	t-braid	60
nails	65	rebond chip foam	33	t-coupler, air line accessories	49
• ardox		rebond edge	61	t-nuts	29
• decorative	73,74	rebond sheet	58	t-pins	81
• panel nails	75	Regalite VuFlex	82	tack band for convertible tops	82
nail spacer	40	regulators	45	tackers	48
needles• for hand sewing	45	regulator for compressor tools	50	tacking strip	76-77
• for tufting	43	Ringflex	61	tacks	73
No-Dent nails	14	ripping tool	40	tailors chalk	81
No-Sag	64-65	Robertson wood screws	73	thread	78-80
No-Sag bender	44	rocker base and springs	63	three prong edge wire clip	67
No-Sag cutter	44	Rodon deck lining	37	throw cushions	33
No-Sag lever stretcher	42	rubber webbing	68	ticking, downproof	36
NPF padding	38	rulers - aluminum, wooden	43	tissue cord	60
nylon Perma-Lock fasteners	16			tools	40-53
				tonneau cover material	83
O		S		topping, auto	83
offset boat seat hinges	58	S hooks	87	topping, marine	54
Olfa knife, blades	42	safety blow gun	49	top stops	20,57
Oxford hammered nails	74	school chalk	81	trideck aka Deck Pad	39
oil, sewing machine	81	screw hole plugs	75	Trim-Flex	61
		scrimback foam	88	trim adhesive	7
P		seam stretcher	42	trimming knives	42
padding, for Landau tops	84	seaming cord	60	trunk lining	84
paintable silicone	10	seat belt webbing	88	tucking tool	40
panel board, auto	88	seat heater (auto)	89	Tuff twine	81
panel nails	75	sectioned sofa joiner	63	tufting needle, clasps	43
paper covered wire	67	setting tools - grommet, hand type	53	tufting twine	81
paper welting cord	60	- Press-n-Snap	86	Tunnel Tie	78
pellon skirt lining	38	shears (scissors)	41	twin welt (double welt)	60
permastick, over tacking strip	76	shells, for buttons	12	twin wheel casters	23,24
pipng	60	shock cord	58	twine	81
pipng tins	43	shoe tacks	73	twist pins	18
Pirelli rubber webbing	68	shredded poly foam	33	two sided buttons - pivot tacks	14
pivot buttons	14	side release buckles	57	Typar lining	37
plastic boat zipper	57	silicone	10		
plastic buttons	14	silk film	52	U	
plastic, clear • Auto - VuFlex	82	skewers	45	U-cut foam slicer	44
• marine	54	skirt lining	38	UltraFlex seat webbing	68
plastic handled regulators	45	sliders	20	universal pads - auto tops	82
plastic head skewers	45	snap fasteners	15	upholsterers nails	74
platform rocker springs	63	snap hooks	18	urethane foam	30-33
Pli-Grip (Flex-trim)	77	sockets for casters	22		
pliers, webbing, clip, hog	42	sofa bag	69	V	
plugs - Christmas tree	87	sofa bed mechanism	62	valance stiffener	38
PM-5 bench type setting machine	53	soft edge seat spring	66	Velcro and Velcoins	19
polished plastic sheets	54	solvents	7	ventilator, boat top	56
poly bags, for sofas & chairs	69	sponge core	85	vent grommets and washers	53
poly rod, hollow or solid	60	spray gun - for liquids	50	ventilator setting tool	53
polyester decking	38	spring clip pliers	42	vinyl cleaner	9
polyester filling	35	spring edging	61	vinyl quilted patterns	59
polyester thread (Perma Spun)	79	spring twine	81	vinyl welt - extruded	56
polypro webbing	55	spring welt	60	viscon zipper	57
polyurethane foam	32	springs, coil	66		
pop rivets	87	split retainer backs	14	W	
Press-n-Snap setting tool	86	spur grommets	18	washers	87
prongs, for buttons	13	staple removers	40	webbing	68
prong t-nuts	75	staplers	48	webbing clips	57
Propex FLW	37	staples	70-72	webbing stretcher	40
protectors, vinyl and fabric	9,10	stainless steel snap fasteners	17	webbing stretcher pliers	42
Pull-the-Dot fasteners	17	steamers, Jiffy type	52	white resin glue	7
punch, revolving leather type	42	stitching twine	81	windcord, snap on	85
punches, hand	86	stops, bottom, top, for zipper	20,57	windlace	85
PVC hose, air line accessories	49	StripBit	40	windshield studs (clip)	15
		stripping hammer	40		
Q		styrofoam beads for bean bag chairs	35	Y	
Qualux foam	30	swivel plates for chair bases	63	yardage guide for chairs and couches	5
Quick clip thread clippers	41	synflex hose, for compressor	49		
Quick Guide - Cutaway chair	4	synthetic linings	37	Z	
quilted decking	38	Syntwine	81	zipper	87
quilted vinyl patterns	59	syphon type 118 glue gun	50	• auto top	57
				• boat top	20,21
				• cushion	20,21
				zipper glossary	20



- **(u)phoria ! Totally Custom Contract Vinyl**
- **Crypton[®], Vinyls, Flame Retardant Fabrics**
- **Health Care, Speciality Fabrics and Vinyls**
- **Auto and Marine Interior Components**
- **Decorative Upholstery Finishes**
- **Custom Foam Fabrication**

Triden Distributors Limited

**922 Dillingham Road
Pickering, ON L1W 1Z5**

905.421.2955

orders@triden.com

triden.com